

300N Wireless LAN High Power POE Access Point

User's Manual

Version 1.0

(November, 2011)

COPYRIGHT

Copyright ©2011/2012 by this company. All rights reserved. No part of this publication may be reproduced, transmitted, transcribed, stored in a retrieval system, or translated into any language or computer language, in any form or by any means, electronic, mechanical, magnetic, optical, chemical, manual or otherwise, without the prior written permission of this company

This company makes no representations or warranties, either expressed or implied, with respect to the contents hereof and specifically disclaims any warranties, merchantability or fitness for any particular purpose. Any software described in this manual is sold or licensed "as is". Should the programs prove defective following their purchase, the buyer (and not this company, its distributor, or its dealer) assumes the entire cost of all necessary servicing, repair, and any incidental or consequential damages resulting from any defect in the software. Further, this company reserves the right to revise this publication and to make changes from time to time in the contents thereof without obligation to notify any person of such revision or changes.

Federal Communication Commission

Interference Statement

FCC Part 15

This equipment has been tested and found to comply with the limits for a Class B digital device, pursuant to Part 15 of FCC Rules. These limits are designed to provide reasonable protection against harmful interference in a residential installation. This equipment generates, uses, and can radiate radio frequency energy and, if not installed and used in accordance with the instructions, may cause harmful interference to radio communications. However, there is no guarantee that interference will not occur in a particular installation. If this equipment does cause harmful interference to radio or television reception, which can be determined by turning the equipment off and on, the user is encouraged to try to correct the interference by one or more of the following measures:

1. Reorient or relocate the receiving antenna.
2. Increase the separation between the equipment and receiver.
3. Connect the equipment into an outlet on a circuit different from that to which the receiver is connected.
4. Consult the dealer or an experienced radio technician for help.

FCC Caution

This equipment must be installed and operated in accordance with provided instructions and a minimum 20 cm spacing must be provided between computer mounted antenna and person's body (excluding extremities of hands, wrist and feet) during wireless modes of operation.

This device complies with Part 15 of the FCC Rules. Operation is subject to the following two conditions: (1) this device may not cause harmful interference, and (2) this device must accept any interference received, including interference that may cause undesired operation.

Any changes or modifications not expressly approved by the party responsible for compliance could void the authority to operate equipment.

Federal Communication Commission (FCC) Radiation Exposure Statement

This equipment complies with FCC radiation exposure set forth for an uncontrolled environment. In order to avoid the possibility of exceeding the FCC radio frequency exposure limits, human proximity to the antenna shall not be less than 20cm (8 inches) during normal operation.

The antenna(s) used for this transmitter must not be co-located or operating in conjunction with any other antenna or transmitter.

The equipment version marketed in US is restricted to usage of the channels 1-11 only.

R&TTE Compliance Statement

This equipment complies with all the requirements of DIRECTIVE 1999/5/EC OF THE EUROPEAN PARLIAMENT AND THE COUNCIL of March 9, 1999 on radio equipment and telecommunication terminal Equipment and the mutual recognition of their conformity (R&TTE).

The R&TTE Directive repeals and replaces in the directive 98/13/EEC (Telecommunications Terminal Equipment and Satellite Earth Station Equipment) As of April 8, 2000.

Safety

This equipment is designed with the utmost care for the safety of those who install and use it. However, special attention must be paid to the dangers of electric shock and static electricity when working with electrical equipment. All guidelines of this and of the computer manufacture must therefore be allowed at all times to ensure the safe use of the equipment.

EU Countries Intended for Use

The ETSI version of this device is intended for home and office use in Austria, Belgium, Denmark, Finland, France, Germany, Greece, Ireland, Italy, Luxembourg, the Netherlands, Portugal, Spain, Sweden, and the United Kingdom.

The ETSI version of this device is also authorized for use in EFTA member states: Iceland, Liechtenstein, Norway, and Switzerland.

EU Countries Not intended for use

None.

CATALOG

Chapter I: Product Information	1
1-1 Product Introduction	1
1-2 Safety Information	2
1-3 System Requirements	3
1-4 Package Contents.....	4
1-5 Familiar with your new wireless access point	5
Chapter II: System and Network Setup	7
2-1 Installing the access point to your Network	7
2-2 Connecting to wireless access point by web browser.....	8
2-2-1 Windows 95/98/Me IP address setup	8
2-2-2 Windows 2000 IP address setup.....	10
2-2-3 Windows XP IP address setup.....	12
2-2-4 Windows Vista IP address setup.....	14
2-2-5 Connecting to Web Management Interface	17
2-3 View System Status and Information	19
2-4 Select an Operating Mode for Wireless Access Point	21
2-4-1 AP Mode.....	23
2-4-2 Station-Infrastructure	25
2-4-2-1 Wireless Site Survey	26
2-4-3 AP Bridge-Point to Point Mode	28
2-4-4 AP Bridge-Point to Multi-Point Mode	30
2-4-5 AP Bridge-WDS Mode	32
2-4-6 Universal Repeater	34
2-5 WPS Setting.....	37
2-6 Advanced Wireless Settings.....	40
2-7 Wireless Security	43
2-7-1 Disable Security	45
2-7-2 WEP	46
2-7-3 WPA Pre-shared Key.....	48
2-7-4 WPA RADIUS.....	50
2-7-5 802.1x Authentication	52
2-8 MAC Filtering	54
2-9 System Utilities.....	56
2-9-1 LED On/Off	56
2-9-2 Change Password	56

2-9-3 IP Address of the Wireless Access Point.....	58
2-9-4 DHCP Server.....	60
Chapter III: Advanced Configuration	62
3-1 Configuration Backup and Restore.....	62
3-2 Firmware Upgrade.....	63
3-3 System Reset.....	64
Chapter IV: Appendix	65
4-1 Hardware Specification	65
4-2 Troubleshooting	66
4-3 Glossary	68

The setup images used in this manual are for reference only. The contents of these images may vary according to firmware version. The official image contents are based on the newest firmware version.

Chapter I: Product Information

1-1 Product Introduction

Thank you for purchasing this wireless access point! With this high cost-efficiency wireless access point, computers and wireless devices which are compatible with 802.11n can connect to existing wired Ethernet network via this wireless access point, at the speed of 300Mbps.

Easy install procedures allows any computer users to setup a network environment in very short time - within minutes, even inexperienced users. Just follow the instructions given in this user manual, you can complete the setup procedure and release the power of this access point all by yourself!

Other features of this access point including:

- Comply with IEEE 802.3af Powered Device (PD) standard.
- Compatible with IEEE 802.11b/g/n wireless network standard.
- High speed wireless network, six times faster than conventional 802.11g wireless network (up to 300Mbps).
- Allow wireless devices to connect to existing wired network and share network resources.
- Supports DHCP server function.
- Supports 64/128-bit WEP, WPA, and WPA2 wireless data encryption.
- Supports MAC address filtering (Only allow specific wireless device of your choice to connect to this access point).
- Supports WPS (Wi-Fi Protected Setup), simplifies wireless client setup procedures. Even inexperienced user can setup wireless network without network technician's help!
- Easy to use web-based GUI (Graphical User Interface) for network configuration and management purposes.

1-2 Safety Information

In order to keep the safety of users and your properties, please follow the following safety instructions:

1. This access point is designed for indoor use only; DO NOT place this access point outdoor.
2. DO NOT put this access point at or near hot or humid places, like kitchen or bathroom. Also, do not left this access point in the car in summer.
3. DO NOT pull any connected cable with force; disconnect it from the access point first.
4. If you want to place this access point at high places or hang on the wall, please make sure the access point is firmly secured. Falling from high places would damage the access point and its accessories, and warranty will be void.
5. Accessories of this access point, like antenna and power supply, are danger to small children under 3 years old. They may put the small parts in their nose or month and it could cause serious damage to them. **KEEP THIS ACCESS POINT OUT THE REACH OF CHILDREN!**
6. The access point will become hot when being used for long time (***This is normal and is not a malfunction***). DO NOT put this access point on paper, cloth, or other flammable materials.
7. There's no user-serviceable part inside the access point. If you found that the access point is not working properly, please contact your dealer of purchase and ask for help. DO NOT disassemble the access point, warranty will be void.
8. If the access point falls into water when it's powered, DO NOT use your hand to pick it up. Switch the electrical power off before you do anything, or contact an experienced electrical technician for help.
9. If you smell something strange or even see some smoke coming out from the access point or power supply, remove the power supply or switch the electrical power off immediately, and call dealer of purchase for help.

1-3 System Requirements

- Computer or network devices with wired or wireless network interface card.
- Web browser (*Microsoft Internet Explorer 4.0 or above, Netscape Navigator 4.7 or above, Opera web browser, or Safari web browser*).
- An available AC power socket (100 – 240 V, 50/60Hz)

1-4 Package Contents

Before you starting to use this access point, please check if there's anything missing in the package, and contact your dealer of purchase to claim for missing items:

- Wireless Access Point Unit (1 pcs)
- Quick Installation Guide and User Manual CD-ROM (1 pcs)
- A/C Power Adapter (1 pcs)

1-5 Familiar with your new wireless access point

Front Panel

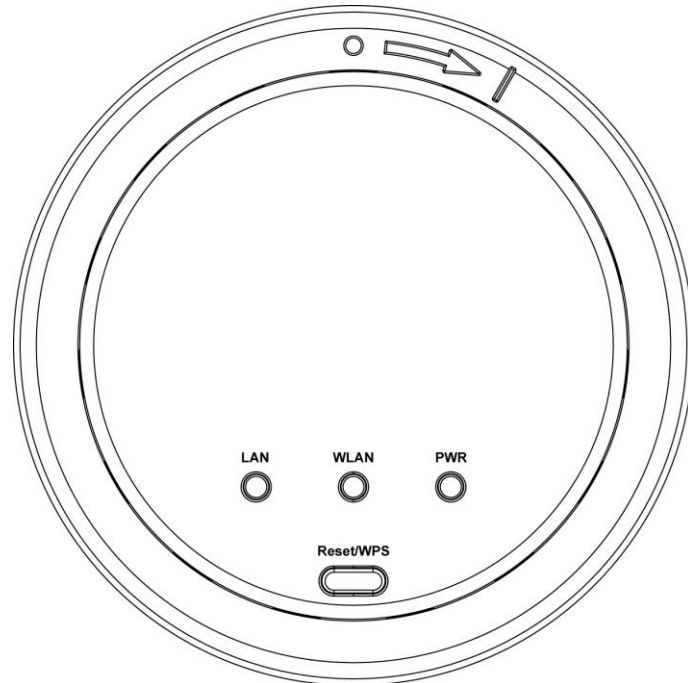

LED Name	Light Status	Description
PWR	On	The access point is switched on and correctly powered.
	Slow Blinking	System is reset to factory default, at the same time WLAN LED is on.
	Off	The access point is switched off.
WLAN	On	Wireless WPS mode is enabled.
	Off	Wireless network is switched off.
	Flashing	Wireless LAN activity (transferring or receiving data).
LAN	On	LAN port is connected
	Off	LAN port is not connected
	Flashing	LAN activity (transferring or receiving data)

Item Name	Description
Reset / WPS	Reset the router to factory default settings (clear all settings) or start WPS function. Press this button and hold for 10 seconds to restore all settings to factory defaults, and press this button for less than 5 seconds to start WPS function.

Back Panel

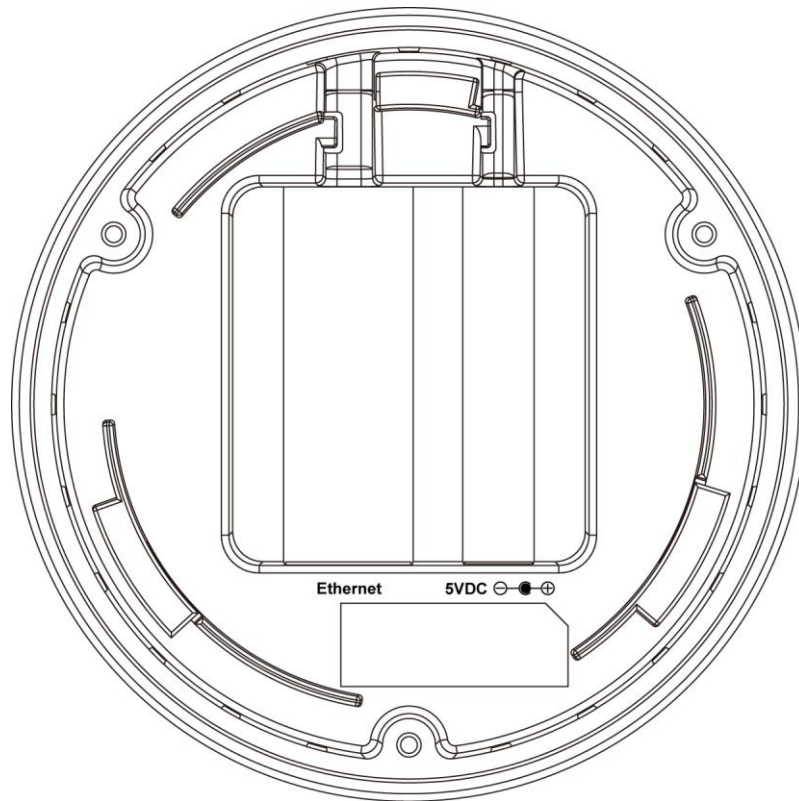

Item Name	Description
Power	Power connector, connects to A/C power adapter.
Ethernet	Local Area Network (LAN) port.

Chapter II: System and Network Setup

2-1 Installing the access point to your Network

Please follow the following instruction to build the network connection between your new wireless access point and your computers, network devices:

1. Place the unit in an appropriate place after conducting a site survey.
2. Connect the access point to ADSL modem, router, or switch/hub in your network through the LAN port of the access point by Ethernet cable.
3. Connect the A/C power adapter to the wall socket, and then connect it to the 'Power' socket of the access point.
4. Please check all LEDs on the front panel. 'PWR' LED should be steadily on, LAN LEDs should be on if the access point is correctly connected to the ADSL modem, router or switch/hub. If PWR LED is not on, or any LED you expected is not on, please recheck the cabling, or jump to '**4-2 Troubleshooting**' for possible reasons and solution.

2-2 Connecting to wireless access point by web browser

After the network connection is built, the next step you should do is setup the access point with proper network parameters, so it can work properly in your network environment.

Before you can connect to the access point and start configuration procedures, your computer must be able to get an IP address automatically (use dynamic IP address). If it's set to use static IP address, or you're unsure, please follow the following instructions to configure your computer to use dynamic IP address:

If the operating system of your computer is....

Windows 95/98/Me	- please go to section 2-2-1
Windows 2000	- please go to section 2-2-2
Windows XP	- please go to section 2-2-3
Windows Vista	please go to section 2-2-4

2-2-1 Windows 95/98/Me IP address setup

1. Click 'Start' button (it should be located at lower-left corner of your computer), then click control panel. Double-click *Network* icon, and *Network* window will appear. Select 'TCP/IP', then click 'Properties'.

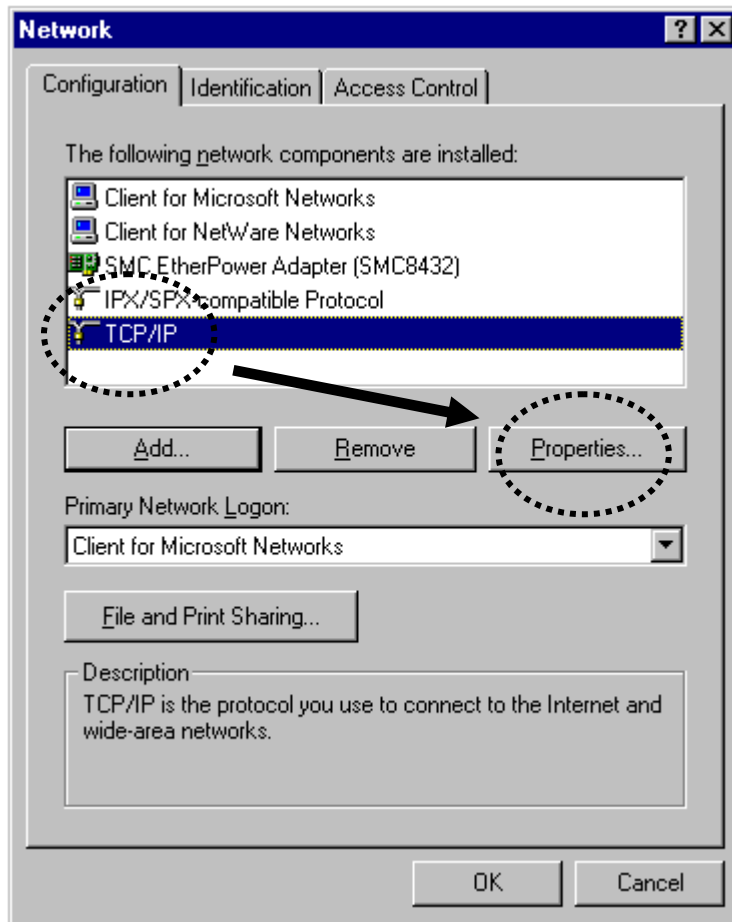

2. Select 'Specify an IP address', then input the following settings in respective field:

IP address: 192.168.2.2

Subnet Mask: 255.255.255.0

click 'OK' when finish.

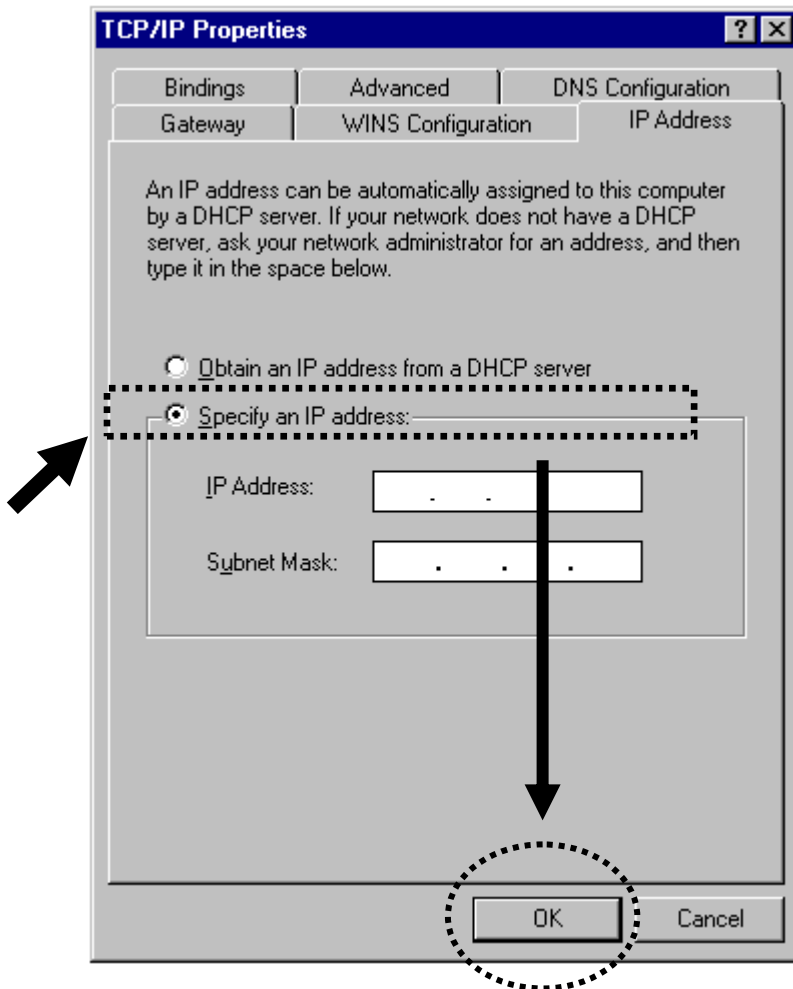

2-2-2 Windows 2000 IP address setup

1. Click 'Start' button (it should be located at lower-left corner of your computer), then click control panel. Double-click **Network and Dial-up Connections** icon, double click **Local Area Connection**, and **Local Area Connection Properties** window will appear. Select 'Internet Protocol (TCP/IP)', then click 'Properties'

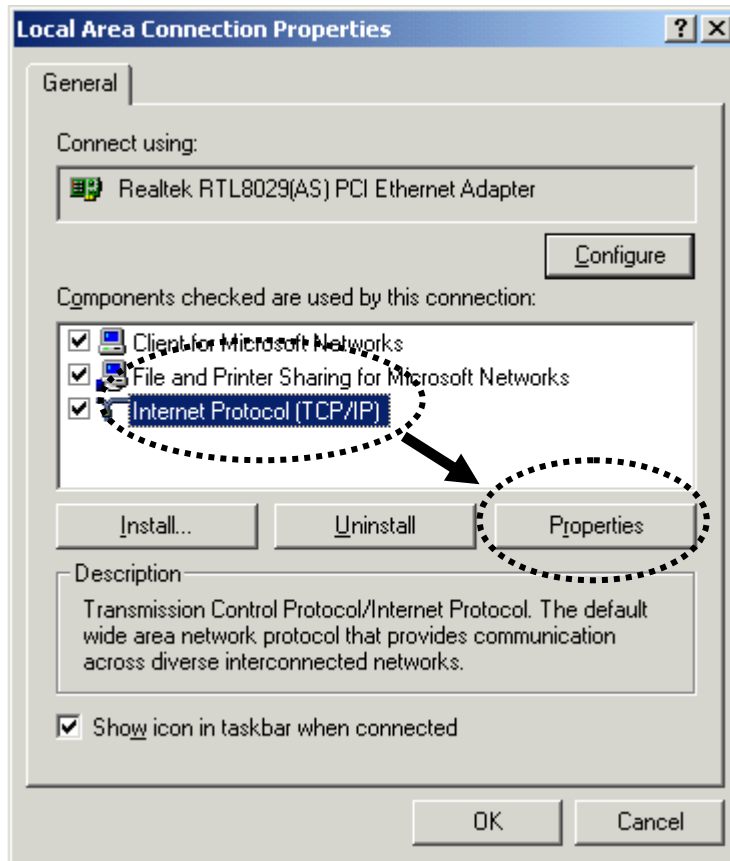

2. Select 'Use the following IP address', then input the following settings in respective field:

IP address: 192.168.2.2

Subnet Mask: 255.255.255.0

click 'OK' when finish.

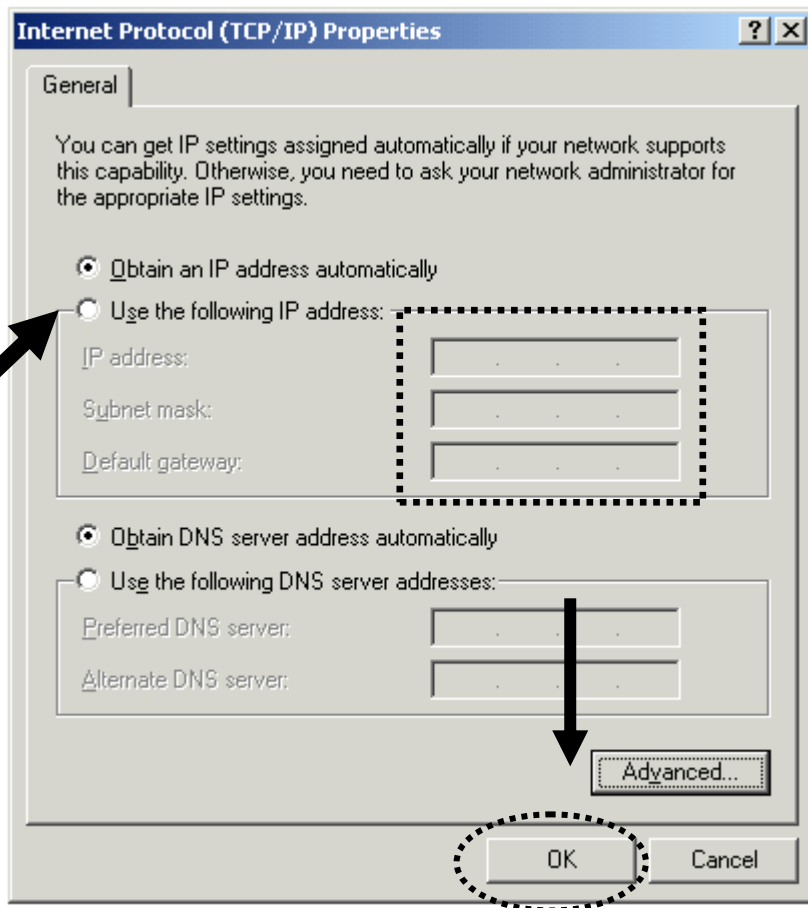

2-2-3 Windows XP IP address setup

1. Click 'Start' button (it should be located at lower-left corner of your computer), then click control panel. Double-click **Network and Internet Connections** icon, click **Network Connections**, and then double-click **Local Area Connection, Local Area Connection Status** window will appear, and then click 'Properties'

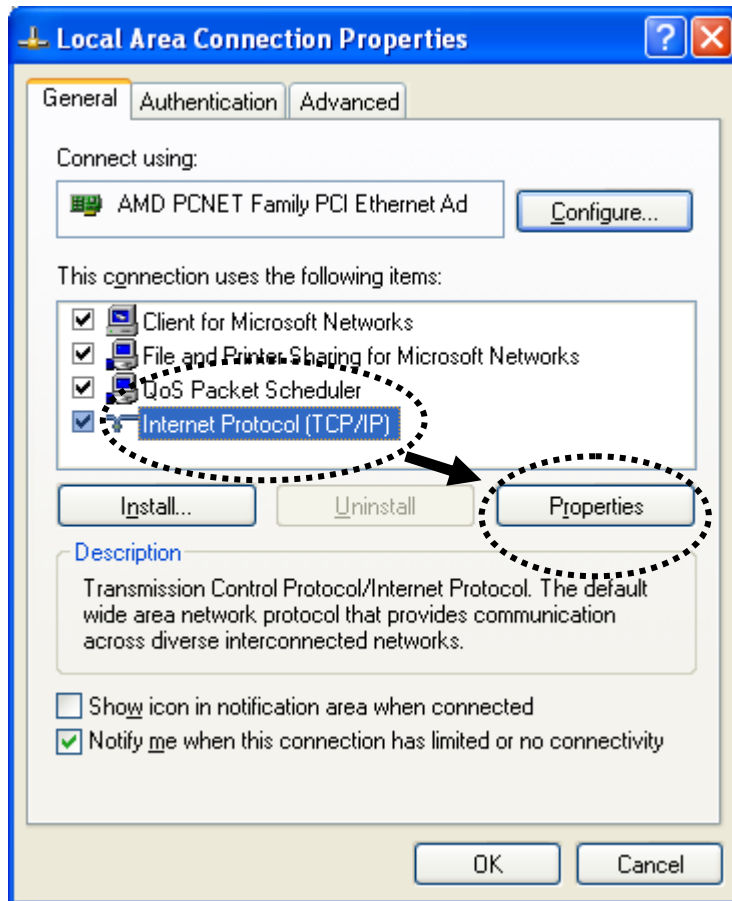

2. Select 'Use the following IP address', then input the following settings in respective field:

IP address: 192.168.2.2

Subnet Mask: 255.255.255.0

click 'OK' when finish.

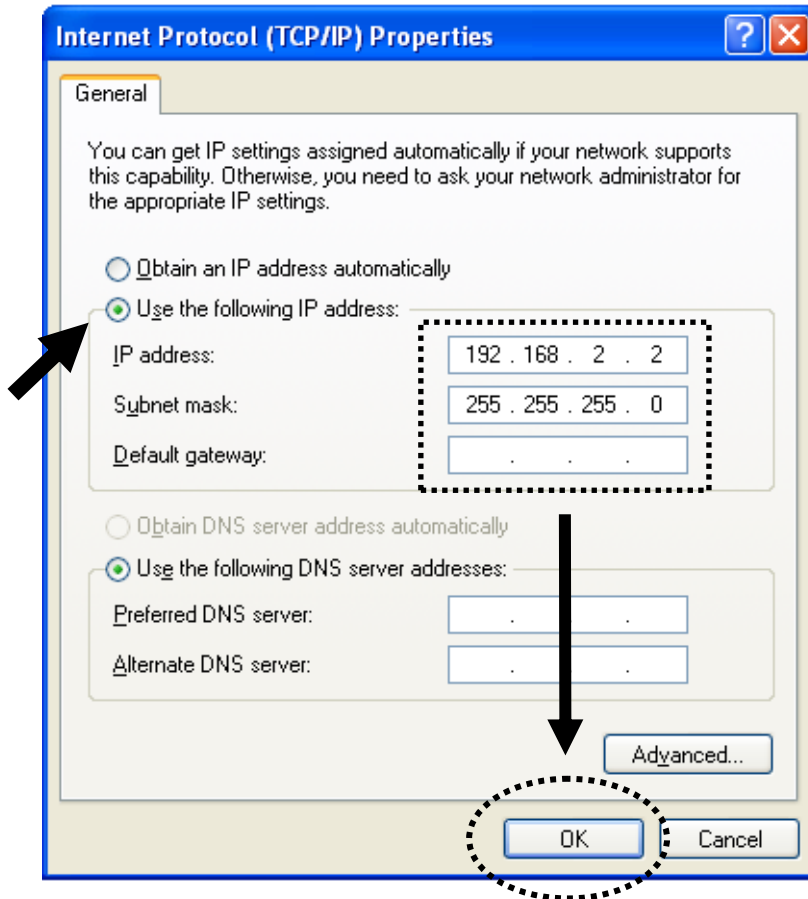

2-2-4 Windows Vista IP address setup

1. Click 'Start' button (it should be located at lower-left corner of your computer), then click control panel. Click ***View Network Status and Tasks***, then click ***Manage Network Connections***..Right-click ***Local Area Network***, then select '***Properties***'. ***Local Area Connection Properties*** window will appear, select 'Internet Protocol Version 4 (TCP / IPv4), and then click 'Properties'

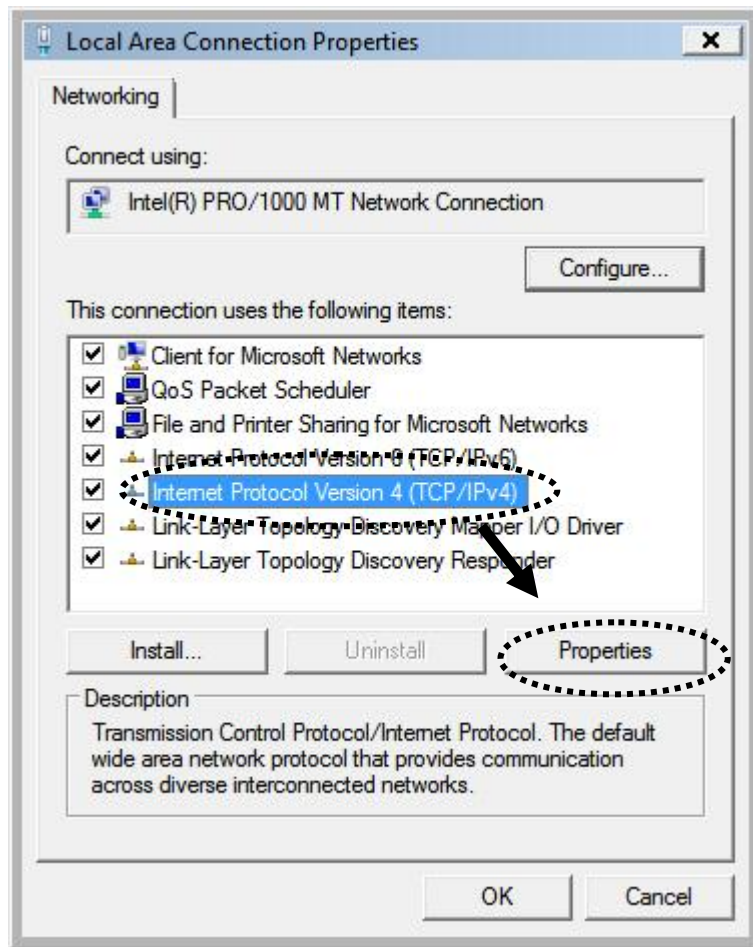

2. Select 'Use the following IP address', then input the following settings in respective field:

IP address: 192.168.2.2

Subnet Mask: 255.255.255.0

click 'OK' when finish.

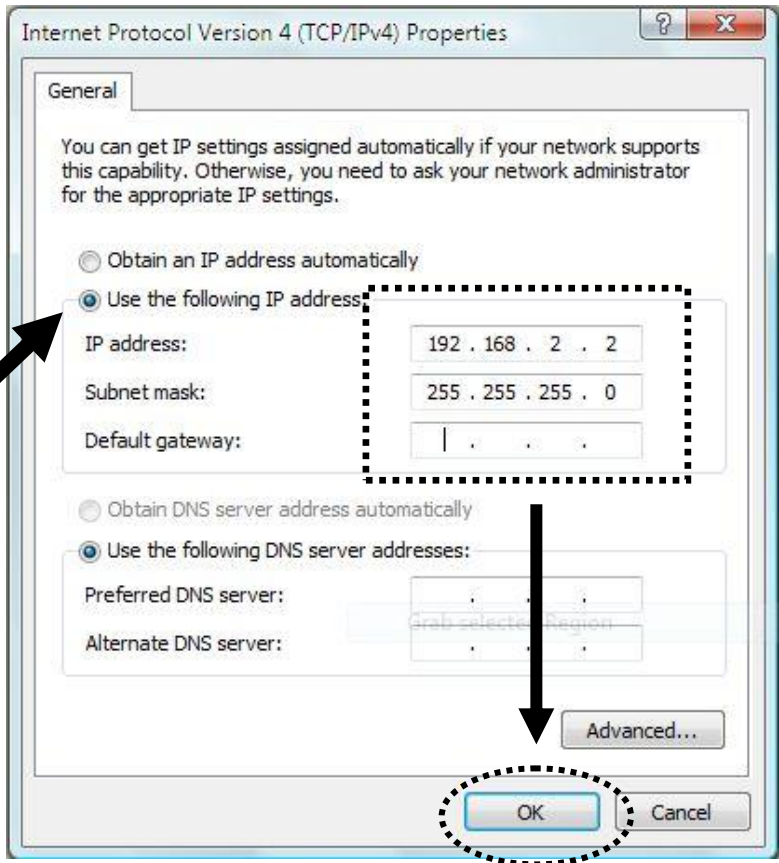

2-2-5 Connecting to Web Management Interface

All functions and settings of this access point must be configured via web management interface. Please start your web browser, and input '192.168.2.1' in address bar, then press 'Enter' key. The following message should be shown:

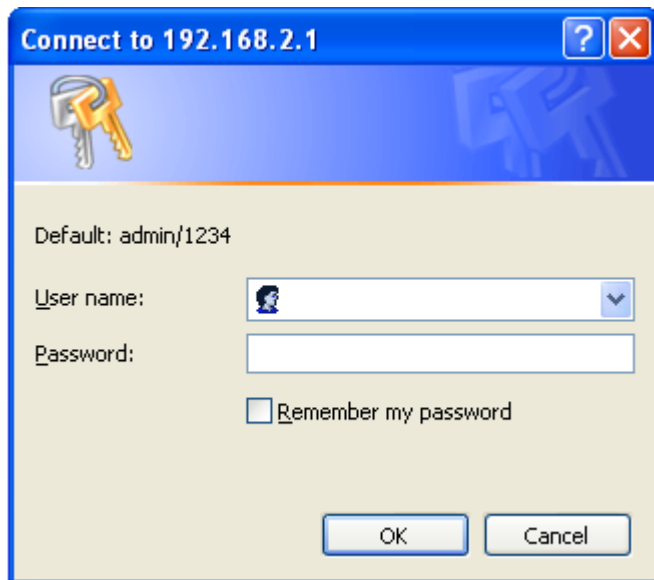

Please input user name and password in the field respectively, default user name is 'admin', and default password is '1234', then press 'OK' button, and you can see the web management interface of this access point:

Access Point

- Home
- Basic Settings
- WPS Setting
- Advanced Settings
- Security
- MAC Filtering
- System Utility
- Configuration Tool
- Upgrade
- Reset

Status and Information

You can use the information to monitor the Access Point's MAC address, runtime code and hardware version.

System	
Uptime	0day:0h:3m:59s
Hardware Version	Rev. A
Runtime Code Version	1.00c

Wireless Configuration	
Mode	AP
ESSID	default
Channel Number	11
Security	Disable
BSSID	00:e0:4c:81:96:c1
Associated Clients	0

LAN Configuration	
IP Address	192.168.2.1
Subnet Mask	255.255.255.0
Default Gateway	0.0.0.0
MAC Address	00:e0:4c:81:96:c1

NOTE: If you can't see the web management interface, and you're being prompted to input user name and password again, it means you didn't input username and password correctly. Please retype user name and password again. If you're certain about the user name and password you type are correct, please go to '4-2 Troubleshooting' to perform a factory reset, to set the password back to default value.

2-3 View System Status and Information

After you connected to the access point by web browser, the first thing you see is ‘Status and Information’ page. All system and network related information of this access point will be displayed here. The information is very helpful when you want to know the detailed information of your access point, and when you try to fix the communication problem between this access point and other wired / wireless computer / devices.

You can click ‘Home’ on the left, and the system status and information will be displayed, as shown below:

Access Point

- Home
- Basic Settings
- WPS Setting
- Advanced Settings
- Security
- MAC Filtering
- System Utility
- Configuration Tool
- Upgrade
- Reset

Status and Information

You can use the information to monitor the Access Point's MAC address, runtime code and hardware version.

System	
Uptime	0day:0h:3m:59s
Hardware Version	Rev. A
Runtime Code Version	1.00c
Wireless Configuration	
Mode	AP
ESSID	default
Channel Number	11
Security	Disable
BSSID	00:e0:4c:81:96:c1
Associated Clients	0
LAN Configuration	
IP Address	192.168.2.1
Subnet Mask	255.255.255.0
Default Gateway	0.0.0.0
MAC Address	00:e0:4c:81:96:c1

Here are descriptions of every item:

<i>Up time</i>	<i>Displays the total passed time since the wireless access point is powered.</i>
<i>Hardware Version</i>	<i>Displays hardware version. This information is helpful when you need online help from the dealer</i>

	<i>of purchase.</i>
<i>Runtime Code Version</i>	<i>Displays current firmware version. If you want to perform firmware upgrade, this number will help you to determine if you need such upgrade.</i>
<i>Mode</i>	<i>Displays current wireless operating mode (see next Section)</i>
<i>ESSID</i>	<i>Displays current ESSID (the name used to identify this wireless access point)</i>
<i>Channel Number</i>	<i>Displays current wireless channel number</i>
<i>Security</i>	<i>Displays current wireless security setting</i>
<i>BSSID</i>	<i>Displays current BSSID (a set of unique identification name of this access point, it can not be modified by user)</i>
<i>Associated Clients</i>	<i>Displays the number of connected wireless client</i>
<i>IP Address</i>	<i>Displays the IP address of this wireless access point</i>
<i>Subnet Mask</i>	<i>Displays the net mask of IP address</i>
<i>Default Gateway</i>	<i>Displays the IP address of default gateway</i>
<i>MAC address</i>	<i>Displays the MAC address of LAN interface</i>

2-4 Select an Operating Mode for Wireless Access Point

This access point can be operated in different modes; you can click ‘Basic Setting’ on the left of web management interface to select an operating mode you want to meet for different needs:

You can click ‘Mode’ dropdown menu to select operating mode, and there are 6 operating modes available:

<i>AP</i>	<i>Access point mode, allows wireless clients to connect to access point and exchange data with the devices connected to the wired network.</i>
<i>Station-Infrastructure</i>	<i>Enable the Ethernet device such us TV and Game player connected to the access point to a wireless client.</i>
<i>AP Bridge-Point to Point</i>	<i>Establish wireless connection with another wireless access point using the same mode, and link the wired network which these two wireless access points connected to together. Only one access point can be connected in this mode.</i>
<i>AP Bridge-Point to Multi-Point</i>	<i>Establish wireless connection with other wireless access points using the same mode, and link the wired network which these wireless access points</i>

	<i>connected to together. Up to 4 access points can be connected in this mode.</i>
<i>AP Bridge-WDS</i>	<i>This mode is similar to 'AP Bridge to Multi-Point', but access point is not work in bridge-dedicated mode, and will be able to accept wireless clients while the access point is working as a wireless bridge.</i>
<i>Universal Repeater</i>	<i>This product can act as a wireless range extender that will help you to extend the networking wirelessly. The access point can act as Station and AP at the same time. It can use Station function to connect to a Root AP and use AP function to service all wireless clients within its coverage.</i>

Please select one wireless operating mode, for detailed descriptions of every operating mode; please refer to Section 2-4-1 to 2-4-6 listed below.

2-4-1 AP Mode

This is the most common mode. When in AP mode, this access point acts as a bridge between 802.11b/g/Draft-N wireless devices and wired Ethernet network, and exchange data between them.

When you select ‘AP’, the following options will be displayed:

The screenshot shows a configuration window for AP Mode. It contains the following fields and controls:

- Mode :** A dropdown menu set to 'AP'.
- Band :** A dropdown menu set to '2.4 GHz (B+G+N)'.
- MAIN ESSID :** A text input field containing 'default'.
- Channel Number :** A dropdown menu set to '11'.
- Associated Clients :** A button labeled 'Show Active Clients'.

At the bottom right of the window, there are two buttons: 'Apply' and 'Cancel'.

Here are descriptions of every setup item:

<p><i>Band</i></p>	<p><i>Please select the wireless band you wish to use. By selecting different band setting, you'll be able to allow or deny the wireless client of a certain band.</i></p> <p><i>If you select 2.4GHz (B), 2.4GHz (N), or 2.4GHz (G), only wireless clients using the wireless band you select (802.11b, 802.11 Draft-N, or 802.11g) will be able to connect to this access point.</i></p> <p><i>If you select 2.4GHz (B+G), then only wireless clients using 802.11b and 802.11g band will be able to connect to this access point.</i></p> <p><i>If you want to allow 802.11b, 802.11g, and 802.11 Draft-N clients to connect to this access point, select 2.4GHz (B+G+N).</i></p>
<p><i>Main ESSID</i></p>	<p><i>Please input the ESSID (the name used to identify</i></p>

	<i>this wireless access point) here. You can input up to 32 alphanumerical characters. PLEASE NOTE THAT ESSID IS CASE SENSITIVE.</i>
<i>Channel Number</i>	<i>Please select a channel number you wish to use. If you know a certain channel number is being used by other wireless access points nearby, please refrain from using the same channel number</i>
<i>Associated Clients</i>	<i>Click 'Show Active Clients' button and a new popup window will appear which contains the information about all wireless clients connected to this access point. You can click 'Refresh' button in popup window to keep information up-to-date.</i>

After you finish with setting, please click 'Apply', and the following message will be displayed:

Save setting successfully!

You may press CONTINUE button to continue configuring other settings or press APPLY button to restart the system for changes to take effect

When you see this message, the settings you made is successfully save. You can click 'Continue' button to back to previous page and continue on other setting items, or click 'Apply' button to restart the wireless access point and the changes will take effect after about 30 seconds.

2-4-2 Station-Infrastructure

In this mode, you can connect the access point to Ethernet device such as TV and Game player to enable the Ethernet device be a wireless station and join to a wireless network through an access point or AP router.

The screenshot shows a configuration interface with the following settings:

- Mode : Station-Infrastructure
- Band : 2.4 GHz (B+G+N)
- MAIN ESSID : default
- Site Survey : Select Site Survey

Here are descriptions of every setup item:

<i>Band</i>	<p><i>Please select the wireless band you wish to use. By selecting different band setting, you'll be able to allow or deny the wireless client of a certain band.</i></p> <p><i>If you select 2.4GHz (B), 2.4GHz (N), or 2.4GHz (G), only wireless clients using the wireless band you select (802.11b, 802.11 Draft-N, or 802.11g) will be able to connect to this access point.</i></p> <p><i>If you select 2.4GHz (B+G), then only wireless clients using 802.11b and 802.11g band will be able to connect to this access point.</i></p> <p><i>If you want to allow 802.11b, 802.11g, and 802.11 Draft-N clients to connect to this access point, select 2.4GHz (B+G+N).</i></p>
<i>Main ESSID</i>	<p><i>Please input the ESSID (the name used to identify this wireless access point) here. You can input up to 32 alphanumeric characters. PLEASE NOTE THAT ESSID IS CASE SENSITIVE.</i></p>
<i>Site Survey</i>	<p><i>When you use this access point as a wireless station for Ethernet network device to have wireless capability, you have to associate it with a</i></p>

	<p><i>working access point. Click ‘Select Site Survey’ button, then a “Wireless Site Survey Table” will pop up. It will list all available access points near by. You can select one access point in the table and it will join wireless LAN through this access point. Please go to Section 2-4-2-1 for more information about the ‘Wireless Site Survey Table’.</i></p>
--	---

After you finish with setting, please click ‘Apply’, and the following message will be displayed:

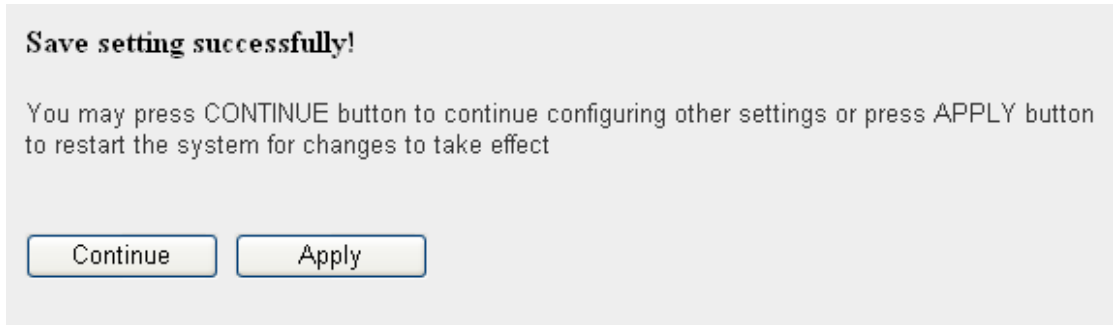

When you see this message, the settings you made is successfully save. You can click ‘Continue’ button to back to previous page and continue on other setting items, or click ‘Apply’ button to restart the wireless access point and the changes will take effect after about 30 seconds.

2-4-2-1 Wireless Site Survey

The table will list the access points nearby as the access point is set to Station mode; you can select one of the access points to associate.

Wireless Site Survey

This page provides tool to scan the wireless network. If any Access Point or IBSS is found, you could choose to connect it manually when client mode is enabled.

Select	SSID	BSSID	Band	Channel	Type	Encryption	Signal
<input type="radio"/>	Ken1	00:1d:73:22:42:9a	(B+G+N)	2	AP	WPA-PSK/WPA2-PSK	44
<input type="radio"/>	6478	00:1f:1f:c3:f8:58	(B+G+N)	11	AP	WPA2-PSK	44
<input type="radio"/>	6F-6400N	00:1f:1f:3a:36:34	(B+G+N)	6	AP	WPA2-PSK	36
<input type="radio"/>	Edimax	00:1f:1f:59:00:11	(B+G+N)	6	AP	no	36
<input type="radio"/>	INNOBAND4000R1	00:64:78:01:01:10	(B+G+N)	1	AP	WPA-PSK/WPA2-PSK	32

Here are descriptions of every setup item:

<i>Select</i>	<i>Click the radio button to select the access point.</i>
<i>SSID</i>	<i>Display the SSID name of the access point.</i>
<i>Channel</i>	<i>Display to channel number of the access point.</i>
<i>BSSID</i>	<i>Display the BSSID (MAC Address) of the access point.</i>
<i>Band</i>	<i>Displays current radio band of the access point.</i>
<i>Channel</i>	<i>Displays current wireless channel number of the access point.</i>
<i>Type</i>	<i>Display the wireless modes include 11b, 11b/g or 11b/g/n or 11n only of the access points.</i>
<i>Encryption</i>	<i>Display the authentication type of the access points. If you have selected the access point with security setting, you have to go to '2-7 Wireless Security' to set the same security with the access point you want to associate.</i>
<i>Signal</i>	<i>The signal strength of each access point will be displayed here. The signal strength is stronger, the connection quality is better.</i>
<i>Refresh</i>	<i>Click this button to refresh the table.</i>
<i>Done</i>	<i>Select an access point and click this button to choose the network. The SSID name of the access point you have selected will be displayed in the Main SSID in the Basic Setting page.</i>
<i>Close</i>	<i>Click this button to close this pop up window.</i>

2-4-3 AP Bridge-Point to Point Mode

In this mode, this wireless access point will connect to another wireless access point which uses the same mode, and all wired Ethernet clients of both wireless access points will be connected together. You can use this mode to connect a network to another network which is physically isolated.

Please note that when you set your access point to this mode, it will not accept regular wireless clients anymore.

When you select ‘AP Bridge-Point to Point’, the following options will be displayed:

Mode : AP Bridge-Point to Point

Band : 2.4 GHz (B+G+N)

Channel Number : 11

MAC address 1 : 000000000000

Set Security : Set Security

Apply Cancel

Here are descriptions of every setup item:

Band	<p><i>Please select the wireless band you wish to use. By selecting different band setting, you'll be able to allow or deny the wireless client of a certain band.</i></p> <p><i>If you select 2.4GHz (B), 2.4GHz (N), or 2.4GHz (G), only wireless clients using the wireless band you select (802.11b, 802.11 Draft-N, or 802.11g) will be able to connect to this access point.</i></p> <p><i>If you select 2.4GHz (B+G), then only wireless clients using 802.11b and 802.11g band will be able to connect to this access point.</i></p>
-------------	--

	<i>If you want to allow 802.11b, 802.11g, and 802.11 Draft-N clients to connect to this access point, select 2.4GHz (B+G+N).</i>
<i>Channel Number</i>	<i>Please select a channel number you wish to use. The channel number must be same with another wireless access point you wish to connect</i>
<i>MAC address 1</i>	<i>Please input the MAC address of the wireless access point you wish to connect</i>
<i>Set Security</i>	<i>Click this button to select an encryption mode for this wireless link, a new popup window will appear. Please refer to Section 2-7 for detailed descriptions.</i>

After you finish with setting, please click ‘Apply’, and the following message will be displayed:

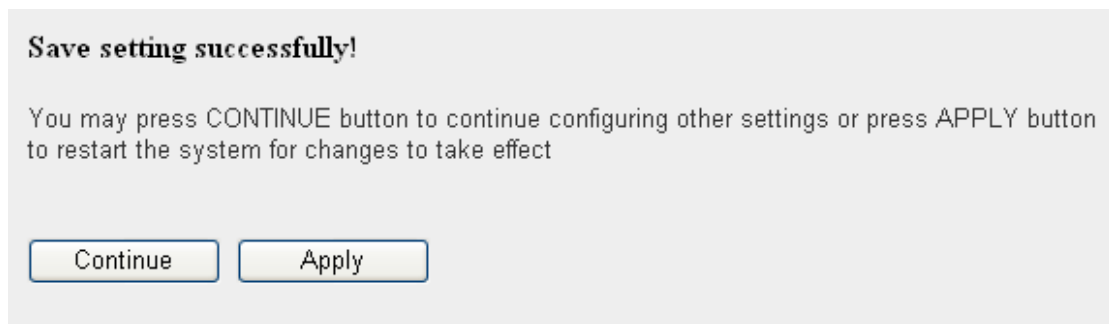

When you see this message, the settings you made is successfully saved, you can click ‘Continue’ button to back to previous page and continue on other setting items, or click ‘Apply’ button to restart the wireless access point and the changes will take effect after about 30 seconds.

2-4-4 AP Bridge-Point to Multi-Point Mode

In this mode, this wireless access point will connect to up to four wireless access points which uses the same mode, and all wired Ethernet clients of every wireless access points will be connected together. You can use this mode to connect a network to other networks which is physically isolated.

Please note that when you set your access point to this mode, it will not accept regular wireless clients anymore.

When you select ‘AP Bridge-Point to Multi-Point’, the following options will be displayed:

The screenshot shows a configuration window with the following fields and buttons:

- Mode : AP Bridge-Point to Multi-Point (dropdown menu)
- Band : 2.4 GHz (B+G+N) (dropdown menu)
- Channel Number : 11 (dropdown menu)
- MAC address 1 : 000000000000 (text input)
- MAC address 2 : 000000000000 (text input)
- MAC address 3 : 000000000000 (text input)
- MAC address 4 : 000000000000 (text input)
- Set Security : Set Security (button)
- Apply (button)
- Cancel (button)

Here are descriptions of every setup item:

<i>Band</i>	<p><i>Please select the wireless band you wish to use. By selecting different band setting, you'll be able to allow or deny the wireless client of a certain band.</i></p> <p><i>If you select 2.4GHz (B), 2.4GHz (N), or 2.4GHz (G), only wireless clients using the wireless band you select (802.11b, 802.11 Draft-N, or 802.11g) will be able to connect to this access point.</i></p> <p><i>If you select 2.4GHz (B+G), then only wireless clients using 802.11b and 802.11g band will be</i></p>
-------------	--

	<p><i>able to connect to this access point.</i></p> <p><i>If you want to allow 802.11b, 802.11g, and 802.11 Draft-N clients to connect to this access point, select 2.4GHz (B+G+N).</i></p>
<i>Channel Number</i>	<i>Please select a channel number you wish to use. The channel number must be same with another wireless access point you wish to connect</i>
<i>MAC address 1-4</i>	<i>Please input the MAC address of the wireless access point you wish to connect</i>
<i>Set Security</i>	<i>Click this button to select an encryption mode for this wireless link, a new popup window will appear. Please refer to Section 2-7 for detailed descriptions.</i>

After you finish with setting, please click ‘Apply’, and the following message will be displayed:

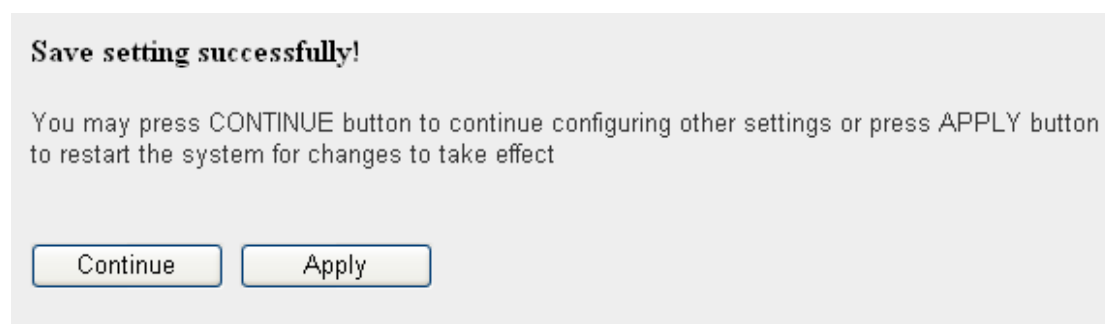

When you see this message, the settings you made is successfully save. You can click ‘Continue’ button to back to previous page and continue on other setting items, or click ‘Apply’ button to restart the wireless access point and the changes will take effect after about 30 seconds.

2-4-5 AP Bridge-WDS Mode

In this mode, this wireless access point will connect to up to four wireless access points which uses the same mode, and all wired Ethernet clients of every wireless access points will be connected together. You can use this mode to connect a network to other networks which is physically isolated.

When you use this mode, this access point is still able to accept wireless clients.

When you select ‘AP Bridge-WDS’, the following options will be displayed:

The screenshot displays a configuration window for AP Bridge-WDS mode. The settings are as follows:

- Mode : AP Bridge-WDS
- Band : 2.4 GHz (B+G+N)
- MAIN ESSID : default
- Channel Number : 6
- Associated Clients : Show Active Clients
- MAC address 1 : 000000000000
- MAC address 2 : 000000000000
- MAC address 3 : 000000000000
- MAC address 4 : 000000000000
- Set Security : Set Security

Buttons for 'Apply' and 'Cancel' are located at the bottom right of the window.

Here are descriptions of every setup item:

<i>Band</i>	<p><i>Please select the wireless band you wish to use. By selecting different band setting, you'll be able to allow or deny the wireless client of a certain band.</i></p> <p><i>If you select 2.4GHz (B), 2.4GHz (N), or 2.4GHz (G), only wireless clients using the wireless band</i></p>
-------------	---

	<p><i>you select (802.11b, 802.11 Draft-N, or 802.11g) will be able to connect to this access point.</i></p> <p><i>If you select 2.4GHz (B+G), then only wireless clients using 802.11b and 802.11g band will be able to connect to this access point.</i></p> <p><i>If you want to allow 802.11b, 802.11g, and 802.11 Draft-N clients to connect to this access point, select 2.4GHz (B+G+N).</i></p>
<i>MAIN ESSID</i>	<i>Please input the ESSID (the name used to identify this wireless access point) here. You can input up to 32 alphanumerical characters. PLEASE NOTE THAT ESSID IS CASE SENSITIVE.</i>
<i>Channel Number</i>	<i>Please select a channel number you wish to use. The channel number must be same with another wireless access point you wish to connect</i>
<i>Associated Clients</i>	<i>Click ‘Show Active Clients’ button and a new popup window will appear which contains the information about all wireless clients connected to this access point. You can click ‘Refresh’ button in popup window to keep information up-to-date.</i>
<i>MAC address 1-4</i>	<i>Please input the MAC address of the wireless access point you wish to connect</i>
<i>Set Security</i>	<i>Click this button to select an encryption mode for this wireless link, a new popup window will appear. Please refer to Section 2-7 for detailed descriptions.</i>

After you finish with setting, please click ‘Apply’, and the following message will be displayed:

Save setting successfully!

You may press CONTINUE button to continue configuring other settings or press APPLY button to restart the system for changes to take effect

When you see this message, the settings you made is successfully save. You can click ‘Continue’ button to back to previous page and continue on other setting items, or click ‘Apply’ button to restart the wireless access point and the changes will take effect after about 30 seconds.

2-4-6 Universal Repeater

In this mode, the access point can act as a wireless repeater; it can be Station and AP at the same time. It can use Station function to connect to a Root AP and use AP function to service all wireless stations within its coverage.

NOTE: For Repeater Mode, this access point will demodulate the received signal, checking if this signal is noise for the operating network then have the signal modulated and amplified again. The output power of this mode is the same as that of WDS and normal AP mode.

Mode :	Universal Repeater
Band :	2.4 GHz (B+G+N)
MAIN ESSID :	default
Channel Number :	6
Associated Clients :	<input type="button" value="Show Active Clients"/>
Root AP SSID :	
Select Site Survey	<input type="button" value="Select Site Survey"/>

Here are descriptions of every setup item:

<p><i>Band</i></p>	<p><i>Please select the wireless band you wish to use. By selecting different band setting, you'll be able to allow or deny the wireless client of a certain band.</i></p> <p><i>If you select 2.4GHz (B), 2.4GHz (N), or 2.4GHz (G), only wireless clients using the wireless band you select (802.11b, 802.11 Draft-N, or 802.11g) will be able to connect to this access point.</i></p> <p><i>If you select 2.4GHz (B+G), then only wireless clients using 802.11b and 802.11g band will be able to connect to this access point.</i></p> <p><i>If you want to allow 802.11b, 802.11g, and 802.11 Draft-N clients to connect to this access point, select 2.4GHz (B+G+N).</i></p>
<p><i>MAIN SSID</i></p>	<p><i>Please input the ESSID (the name used to identify this wireless access point) here. You can input up to 32 alphanumerical characters. PLEASE NOTE THAT ESSID IS CASE SENSITIVE.</i></p>
<p><i>Channel Number</i></p>	<p><i>Please select a channel number you wish to use. The channel number must be same with another wireless access point you wish to connect</i></p>
<p><i>Associated Clients</i></p>	<p><i>Click 'Show Active Clients' button and a new popup window will appear which contains the information about all wireless clients connected to this access point. You can click 'Refresh' button in popup window to keep information up-to-date</i></p>
<p><i>Root AP SSID</i></p>	<p><i>In 'Universal Repeater' mode, this device can act as a station to connect to a Root AP. You should assign the SSID of the Root AP here or click 'Select Site Survey' button to choose a Root AP.</i></p>
<p><i>Select Site Survey</i></p>	<p><i>Click 'Select Site Survey' button, then a "Wireless Site Survey Table" will pop up. It will list all available access points near by. You can select one</i></p>

	<i>access point in the table and the access point will join wireless LAN through this access point. Please go to Section 2-4-2-1 for more information about the 'Wireless Site Survey Table'.</i>
--	---

After you finish with setting, please click 'Apply', and the following message will be displayed:

Save setting successfully!

You may press CONTINUE button to continue configuring other settings or press APPLY button to restart the system for changes to take effect

When you see this message, the settings you made is successfully save. You can click 'Continue' button to back to previous page and continue on other setting items, or click 'Apply' button to restart the wireless access point and the changes will take effect after about 30 seconds.

2-5 WPS Setting

Wi-Fi Protected Setup (WPS) is the simplest way to build connection between wireless network clients and this access point. You don't have to select encryption mode and input a long encryption passphrase every time when you need to setup a wireless client, you only have to press a button on wireless client and this access point, and the WPS will do the setup for you.

This access point supports two types of WPS: Push-Button Configuration (PBC), and PIN code. If you want to use PBC, you have to switch this access point to WPS mode and push a specific button on the wireless client to start WPS mode. You can push Reset/WPS button of this access point, or click 'Start PBC' button in the web configuration interface to do this; if you want to use PIN code, you have to provide the PIN code of the wireless client you wish to connect to this access point and then switch the wireless client to WPS mode. The detailed instructions are listed follow:

Note: WPS function of this access point will not work for those wireless clients do not support WPS.

To use WPS function to set encrypted connection between this access point and WPS-enabled wireless client by WPS, click 'WPS Setting' on the left of web management menu, and the following information will be displayed:

Enable WPS

- Wi-Fi Protected Setup Information**

WPS Status:	Configured
Self PinCode:	0
SSID:	default
Authentication Mode:	Disable
Passphrase Key:	
- Device Configure**

Config Mode:	Registrar
Configure via Push Button:	Start PBC
Configure via Client PinCode:	<input type="text"/> Start PIN

Here are descriptions of every setup item:

<i>Enable WPS</i>	<i>Check this box to enable or disable WPS function</i>
<i>Wi-Fi Protected Setup Information</i>	<p><i>All information related to WPS will be displayed here, they're helpful when you're setting up connections by WPS.</i></p> <p><i>WPS Status: Displays WPS status. If data encryption settings of this access point has never been set, 'unConfigured' message will be displayed her. (see Section 2-7 for detailed information); if data encryption settings has been set before, 'Configured' message will be displayed here.</i></p> <p><i>Self PinCode: This is the WPS PIN code of this access point. This code is useful when you need to build wireless connection by WPS with other WPS-enabled wireless devices.</i></p> <p><i>SSID: Displays the SSID (ESSID) of this access point.</i></p>

	<p><i>Authentication Mode: The wireless security authentication mode of this access point will be displayed here. If you don't enable security function of the access point before WPS is activated, the access point will auto set the security to WPA (AES) and generate a set of passphrase key for WPS connection.</i></p> <p><i>Passphrase Key: Displays the WPA passphrase here, all characters will be replaced by asterisk for security reason. If encryption is not set on this access point, nothing will be displayed here.</i></p>
<i>Config Mode</i>	<p><i>There are 'Registrar' and 'Enrollee' modes for the WPS connection. When 'Registrar' is enabled, the wireless clients will follow the access point's wireless settings for WPS connection. When 'Enrollee' mode is enabled, the access point will follow the wireless settings of wireless client for WPS connection.</i></p>
<i>Start PBC</i>	<p><i>Click 'Start PBC' to start Push-Button style WPS setup procedure. This access point will wait for WPS requests from wireless clients for 2 minutes. The 'WLAN' LED on the access point will be steady on for 2 minutes when this access point is waiting for incoming WPS request.</i></p>
<i>Start PIN</i>	<p><i>Please input the PIN code of the wireless client you wish to connect, and click 'Start PIN' button. The 'WLAN' LED on the access point will be steady on when this access point is waiting for incoming WPS request.</i></p>

NOTE: When you're using PBC type WPS setup, you must press 'PBC' button (hardware or software) of wireless client within 120 seconds; if you didn't press PBC button of wireless client within this time period, please press 'PBC' button (hardware or software) of this access point again.

2-6 Advanced Wireless Settings

This wireless access point has many advanced wireless features. Please note that all settings listed here are for experienced users only, if you're not sure about the meaning and function of these settings, please don't modify them, or the wireless performance will be reduced.

You can click 'Advanced Setting' on the left to enter advanced settings menu, and the following message will be displayed:

Advanced Settings

These settings are only for more technically advanced users who have a sufficient knowledge about wireless LAN. These settings should not be changed unless you know what effect the changes will have on your Broadband router.

Fragment Threshold:	2346 (256-2346)
RTS Threshold:	2347 (0-2347)
Beacon Interval:	100 (20- 1024 ms)
DTIM Period:	3 (1-10)
Data Rate:	Auto
N Data Rate:	Auto
Channel Width:	<input checked="" type="radio"/> Auto 20/40 MHZ <input type="radio"/> 20 MHZ
Preamble Type:	<input checked="" type="radio"/> Short Preamble <input type="radio"/> Long Preamble
Broadcast ESSID:	<input checked="" type="radio"/> Enable <input type="radio"/> Disable
WMM:	<input type="radio"/> Enable <input checked="" type="radio"/> Disable
CTS Protect:	<input checked="" type="radio"/> Auto <input type="radio"/> Always <input type="radio"/> None
TX Power:	100 %

Here are descriptions of every setup item:

<i>Fragment Threshold</i>	<i>Set the Fragment threshold of wireless radio. Do not modify default value if you don't know what it is, default value is 2346</i>
<i>RTS Threshold</i>	<i>Set the RTS threshold of wireless radio. Do not modify default value if you don't know what it is, default value is 2347</i>
<i>Beacon Interval</i>	<i>Set the beacon interval of wireless radio. Do not modify default value if you don't know what it is,</i>

	<i>default value is 100</i>
<i>DTIM Period</i>	<i>Set the DTIM period of wireless radio. Do not modify default value if you don't know what it is, default value is 3</i>
<i>Data Rate</i>	<i>Set the wireless data transfer rate to a certain value. Since most of wireless devices will negotiate with each other and pick a proper data transfer rate automatically, it's not necessary to change this value unless you know what will happen after modification.</i>
<i>N Data Rate</i>	<i>Set the data rate of 802.11 Draft-N clients, available options are MCS 0 to MCS 15, it's safe to set this option to 'Auto' and it's not necessary to change this value unless you know what will happen after modification.</i>
<i>Channel Width</i>	<i>Select wireless channel width (bandwidth taken by wireless signals of this access point). It's suggested to select 'Auto 20/40MHz'. Do not change to '20 MHz' unless you know what it is.</i>
<i>Preamble Type</i>	<i>Set the type of preamble of wireless radio, Do not modify default value if you don't know what it is, default setting is 'Short Preamble'.</i>
<i>Broadcast ESSID</i>	<i>Decide if the wireless access point will broadcast its own ESSID or not. You can hide the ESSID of your wireless access point (set the option to 'Disable'), so only people those who know the ESSID of your wireless access point can get connected.</i>
<i>WMM</i>	<i>WMM (Wi-Fi Multimedia) technology, which can improve the performance of certain network applications, like audio/video streaming, network telephony (VoIP), and others. When you enable WMM function, the access point will define the priority of different kinds of data, to give higher priority to applications which require instant responding. Therefore you can improve the performance of such network applications.</i>
<i>CTS Protect</i>	<i>Enabling this setting will reduce the chance of</i>

	<i>radio signal collisions between 802.11b and 802.11g wireless access points. It's recommended to set this option to 'Auto'.</i>
<i>TX Power</i>	<i>You can set the output power of wireless radio. Unless you're using this wireless access point in a really big space, you may not have to set output power to 100%. This will enhance security (malicious / unknown users in distance will not be able to reach your wireless access point).</i>

After you finish with setting, please click 'Apply', and the following message will be displayed:

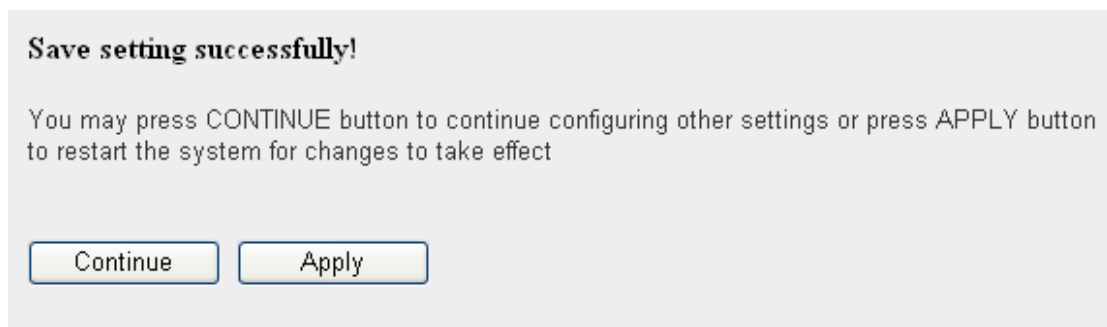

When you see this message, the settings you made is successfully save. You can click 'Continue' button to back to previous page and continue on other setting items, or click 'Apply' button to restart the wireless access point and the changes will take effect after about 30 seconds.

2-7 Wireless Security

This wireless access point provides many types of wireless security (wireless data encryption). When you use data encryption, data transferred by radio signals in the air will become unreadable for those people who don't know correct encryption key (encryption password).

There are two ways to set wireless security:

1. Click 'Security' on the left of web management interface.

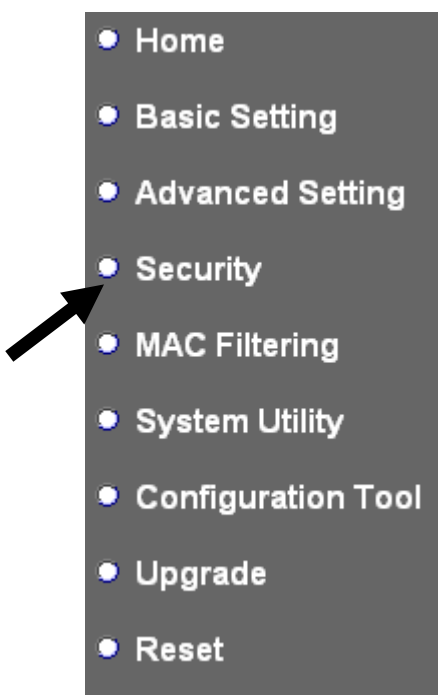

2. Click 'Set Security' button when the wireless operating mode you selected is 'AP Bridge-Point to Point', 'AP Bridge-Point to Multi-Point', or 'AP Bridge-WDS'.

The image shows a configuration window with the following fields and controls:

- Mode : AP Bridge-Point to Point (dropdown menu)
- Band : 2.4 GHz (B+G+N) (dropdown menu)
- Channel Number : 11 (dropdown menu)
- MAC address 1 : 000000000000 (text input field)
- Set Security : Set Security (button)

An arrow points to the 'Set Security' button. At the bottom right, there are 'Apply' and 'Cancel' buttons.

There are four types of security level you can select: Disable (no security - data encryption disabled), WEP, WPA Pre-shared Key, and WPA Radius. Please refer to the following sections for detailed instructions.

NOTE: If you have enabled Multiple SSID function, please select the SSID network you wish to configure in advance.

Please remember it's very important to set wireless security settings properly! Without a proper setting, hackers and intruders may gain access to your local network and do something bad to your computers and servers, which could cause serious problem.

There are several things you can do to improve wireless security:

1. Always enable data encryption. Only disable it when you want to open your wireless access point to the public.
2. Never use simple words as encryption password. Use the random combination of symbols, numbers, and alphabets will greatly improve security.
3. Use WPA when possible - it's much safer than WEP.
4. Change encryption password when you've used it for too long time.

2-7-1 Disable Security

When you select 'Disable', wireless encryption for the network is disabled.

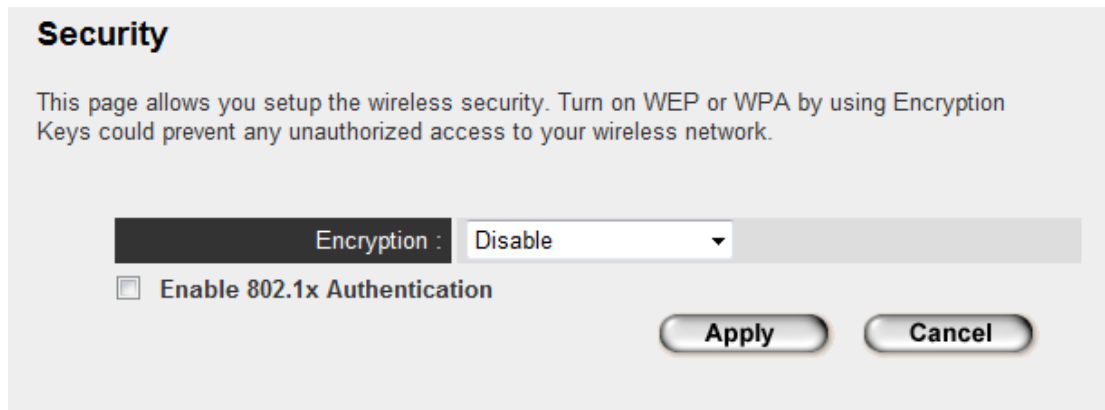

Security

This page allows you setup the wireless security. Turn on WEP or WPA by using Encryption Keys could prevent any unauthorized access to your wireless network.

Encryption : Disable

Enable 802.1x Authentication

Apply **Cancel**

After you finish with setting, please click 'Apply', and the following message will be displayed:

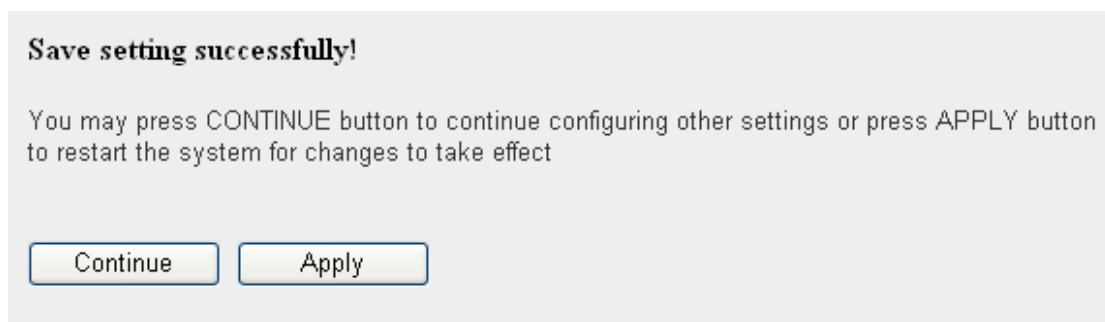

Save setting successfully!

You may press CONTINUE button to continue configuring other settings or press APPLY button to restart the system for changes to take effect

Continue **Apply**

When you see this message, the settings you made is successfully save. You can click 'Continue' button to back to previous page and continue on other setting items, or click 'Apply' button to restart the wireless access point and the changes will take effect after about 30 seconds.

2-7-2 WEP

WEP (Wired Equivalent Privacy) is a common encryption mode, it's safe enough for home and personal use. But if you need higher level of security, please consider using WPA encryption (see next Section).

However, some wireless clients don't support WPA, but only support WEP, so WEP is still a good choice for you if you have such kind of client in your network environment.

When you select 'WEP' as encryption type, the following messages will be displayed:

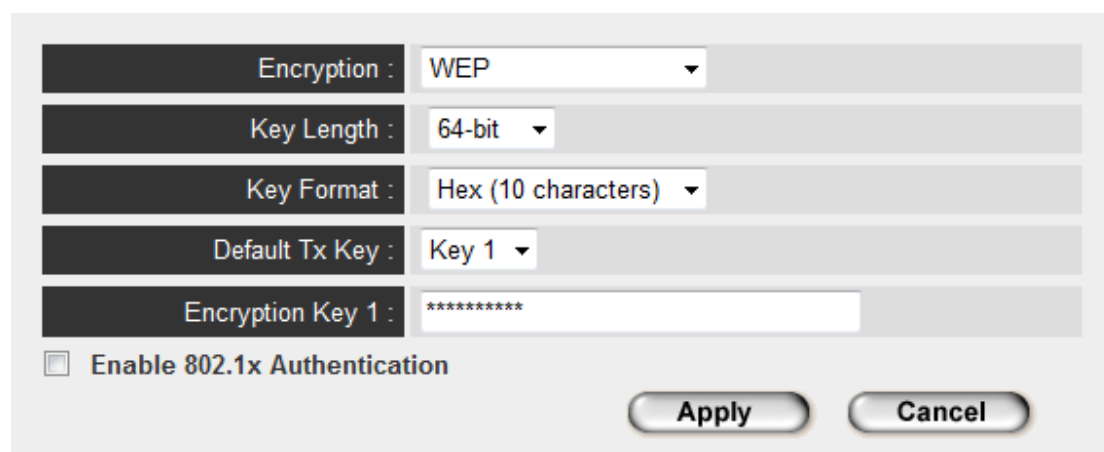

The screenshot shows a configuration window for WEP encryption. It contains five rows of settings, each with a label and a value in a dropdown or text field. The first row is 'Encryption : WEP'. The second row is 'Key Length : 64-bit'. The third row is 'Key Format : Hex (10 characters)'. The fourth row is 'Default Tx Key : Key 1'. The fifth row is 'Encryption Key 1 : *****'. Below these rows is a checkbox labeled 'Enable 802.1x Authentication' which is unchecked. At the bottom right are two buttons: 'Apply' and 'Cancel'.

Here are descriptions of every setup item:

<i>Key Length</i>	<i>There are two types of WEP key length: 64-bit and 128-bit. Using '128-bit' is safer than '64-bit', but will reduce some data transfer performance.</i>
<i>Key Format</i>	<i>There are two types of key format: ASCII and Hex. When you select a key format, the number of characters of key will be displayed. For example, if you select '64-bit' as key length, and 'Hex' as key format, you'll see the message at the right of 'Key Format' is 'Hex (10 characters)', which means the length of WEP key is 10 characters.</i>
<i>Default Tx Key</i>	<i>You can set up to four sets of WEP key, and you can decide which key is being used by default here.</i>

	<i>If you don't know which one you should use, select 'Key 1'.</i>
<i>Encryption Key 1</i>	<i>Input WEP key characters here, the number of characters must be the same as the number displayed at 'Key Format' field. You can use any alphanumerical characters (0-9, a-z, and A-Z) if you select 'ASCII' key format, and if you select 'Hex' as key format, you can use characters 0-9, a-f, and A-F. You must enter at least one encryption key here, and if you entered multiple WEP keys, they should not be same with each other.</i>
<i>Enable 802.1x Authentication</i>	<i>Check this box to enable 802.1x user authentication. Please refer to Section 2-7-5 for detailed instructions.</i>

After you finish with setting, please click 'Apply', and the following message will be displayed:

Save setting successfully!

You may press CONTINUE button to continue configuring other settings or press APPLY button to restart the system for changes to take effect

When you see this message, the settings you made is successfully save. You can click 'Continue' button to back to previous page and continue on other setting items, or click 'Apply' button to restart the wireless access point and the changes will take effect after about 30 seconds.

2-7-3 WPA Pre-shared Key

WPA Pre-shared key is the safest encryption method currently, and it's recommended to use this encryption method to ensure the safety of your data.

When you select 'WPA pre-shared key' as encryption type, the following messages will be displayed:

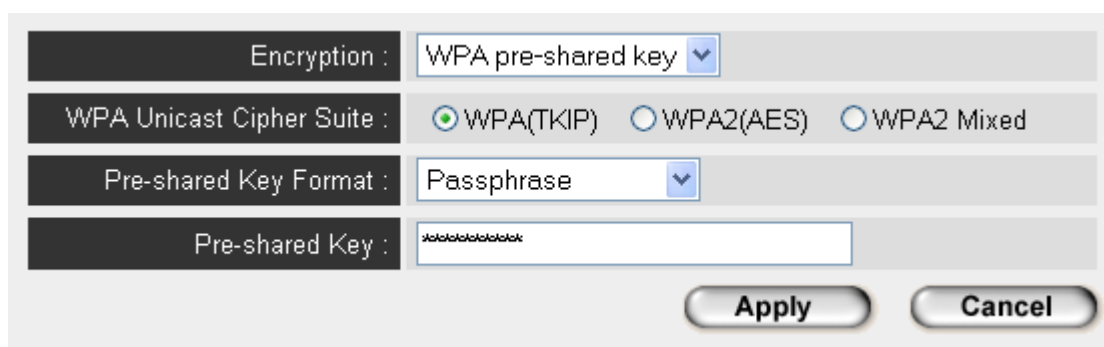

The image shows a configuration dialog box for WPA settings. It has four rows of controls:

- Encryption :** A dropdown menu with 'WPA pre-shared key' selected.
- WPA Unicast Cipher Suite :** Three radio buttons: 'WPA(TKIP)' (selected), 'WPA2(AES)', and 'WPA2 Mixed'.
- Pre-shared Key Format :** A dropdown menu with 'Passphrase' selected.
- Pre-shared Key :** A text input field containing a masked key 'XXXXXXXXXX'.

At the bottom right, there are two buttons: 'Apply' and 'Cancel'.

Here are descriptions of every setup item:

<i>WPA Unicast Cipher Suite</i>	<i>Available options are: WPA (TKIP), WPA2 (AES), and WPA2 Mixed. You can select one of them, but you have to make sure your wireless client support the cipher you selected.</i>
<i>Pre-shared Key Format</i>	<i>Please select the format of pre-shared key here, available options are 'Passphrase' (8 to 63 alphanumerical characters) and 'Hex (64 hexadecimal characters – 0 to 9 and a to f).</i>
<i>Pre-shared Key</i>	<i>Please input pre-shared key according to the key format you selected here. For security reason, don't use simple words).</i>

After you finish with setting, please click 'Apply', and the following message will be displayed:

Save setting successfully!

You may press CONTINUE button to continue configuring other settings or press APPLY button to restart the system for changes to take effect

Continue

Apply

When you see this message, the settings you made is successfully save. You can click 'Continue' button to back to previous page and continue on other setting items, or click 'Apply' button to restart the wireless access point and the changes will take effect after about 30 seconds.

2-7-4 WPA RADIUS

WPA Radius is the combination of WPA encryption method and RADIUS user authentication. If you have a RADIUS authentication server, you can check the identify of every wireless client by user database.

When you select ‘WPA RADIUS’ as encryption type, the following messages will be displayed:

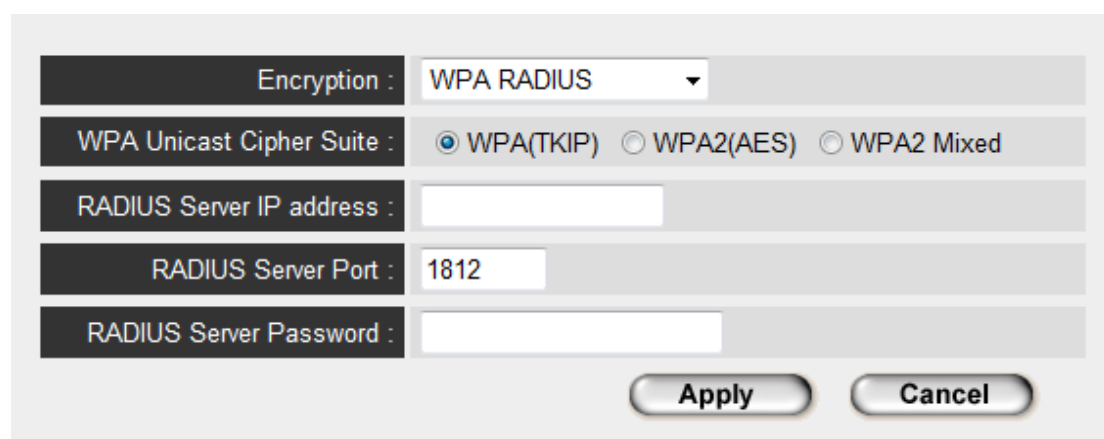

The screenshot shows a configuration window for WPA RADIUS. It includes the following fields and options:

- Encryption :** WPA RADIUS (selected in a dropdown menu)
- WPA Unicast Cipher Suite :** WPA(TKIP) WPA2(AES) WPA2 Mixed
- RADIUS Server IP address :** [Empty text box]
- RADIUS Server Port :** 1812
- RADIUS Server Password :** [Empty text box]

Buttons: Apply, Cancel

Here are descriptions of every setup item:

<i>WPA Unicast Cipher Suite</i>	<i>You can select WPA encryption type here. AES is safer than TKIP, but not every wireless client supports it. Please refer to the specification of your wireless client to decide which encryption type you should use.</i>
<i>RADIUS Server IP address</i>	<i>Please input the IP address of RADIUS authentication server here.</i>
<i>RADIUS Server Port</i>	<i>Please input the port number of RADIUS authentication server here. Default value is 1812.</i>
<i>RADIUS Server Password</i>	<i>Please input the password of RADIUS authentication server here.</i>

After you finish with setting, please click ‘Apply’, and the following message will be displayed:

Save setting successfully!

You may press CONTINUE button to continue configuring other settings or press APPLY button to restart the system for changes to take effect

Continue

Apply

When you see this message, the settings you made is successfully save. You can click 'Continue' button to back to previous page and continue on other setting items, or click 'Apply' button to restart the wireless access point and the changes will take effect after about 30 seconds.

2-7-5 802.1x Authentication

You can enable 802.1x user identification (based on RADIUS user authentication server) by checking 'Enable 802.1x Authentication' box when you select 'Disable' or 'WEP' as encryption type, and the following message will be displayed:

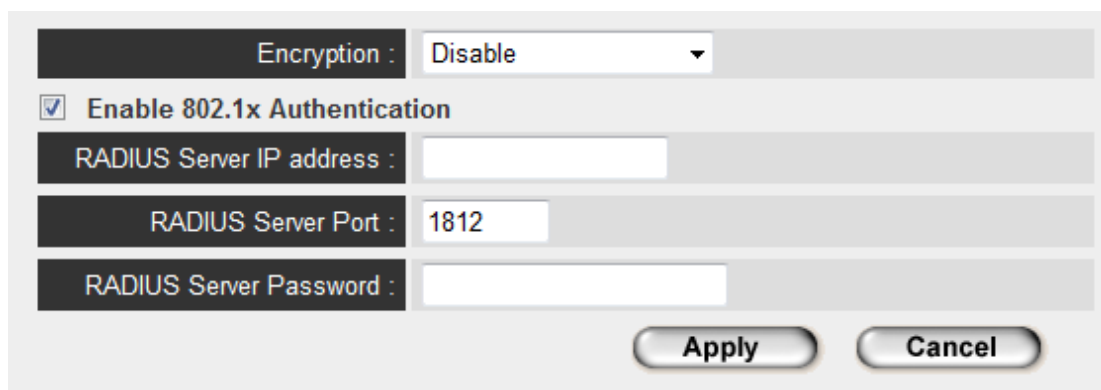

The screenshot shows a configuration window for 802.1x authentication. At the top, there is a label 'Encryption :' followed by a dropdown menu currently showing 'Disable'. Below this is a checked checkbox labeled 'Enable 802.1x Authentication'. Underneath are three input fields: 'RADIUS Server IP address :', 'RADIUS Server Port :', and 'RADIUS Server Password :'. The 'RADIUS Server Port' field contains the value '1812'. At the bottom right of the window are two buttons: 'Apply' and 'Cancel'.

Here are descriptions of every setup item:

<i>Select SSID</i>	<i>Choose the SSID you wish to configure.</i>
<i>Enable 802.1x Authentication</i>	<i>Enable or disable the use of 802.1x user authentication.</i>
<i>RADIUS Server IP address</i>	<i>Please input the IP address of RADIUS authentication server here.</i>
<i>RADIUS Server Port</i>	<i>Please input the port number of RADIUS authentication server here. Default value is 1812.</i>
<i>RADIUS Server Password</i>	<i>Please input the password of RADIUS authentication server here.</i>

After you finish with setting, please click 'Apply', and the following message will be displayed:

Save setting successfully!

You may press CONTINUE button to continue configuring other settings or press APPLY button to restart the system for changes to take effect

Continue

Apply

When you see this message, the settings you made is successfully save. You can click 'Continue' button to back to previous page and continue on other setting items, or click 'Apply' button to restart the wireless access point and the changes will take effect after about 30 seconds.

2-8 MAC Filtering

Another security measure you can use to keep hackers and intruders away is ‘MAC filtering’. You can pre-define a so-called ‘white-list’, which contains MAC addresses of the wireless clients you trust. All other wireless client with the MAC address which is not in your list will be denied by this wireless access point.

To setup MAC filtering, please click ‘MAC Filtering’ on the left of web management interface and the following messages will be displayed:

The screenshot shows the 'MAC Address Filtering Table' interface. It features a table with columns for 'NO.', 'MAC Adres', 'Comment', and 'Select'. Below the table are buttons for 'Delete Selected', 'Delete All', and 'Reset'. A checkbox labeled 'Enable Wireless Access Control' is present. Below this, there is a 'New' button, input fields for 'MAC Address:' and 'Comment:', and 'Add' and 'Clear' buttons. At the bottom are 'Apply' and 'Cancel' buttons. Two callout boxes are present: one pointing to the table area labeled 'Address filtering table (1)' and another pointing to the 'Add' button area labeled 'Add new entry here (2)'.

This page contains two parts of MAC filtering information. All allowed MAC addresses will be listed in upper part (1), and you can add new MAC addresses by components in lower part (2).

Here are descriptions of every setup item:

<i>Select</i>	<i>Check this box to select one or more MAC address(es) to delete.</i>
<i>Delete Selected</i>	<i>Click this button to delete all selected MAC address(es).</i>
<i>Delete All</i>	<i>Delete all MAC address entries.</i>
<i>Reset</i>	<i>Uncheck all selected MAC address entries.</i>

<i>Enable Wireless Access Control</i>	<i>Check this box to enable MAC address restriction, if unchecked, no restriction will be enforced (any wireless client with proper encryption setting will be able to connect to this wireless access point).</i>
<i>MAC address</i>	<i>Input MAC address allowed using this wireless access point here. You don't have to add colon (:) or hyphen (-) by yourself, just input 0 to 9 and a to f here, like 112233445566 or aabbccddeeff.</i>
<i>Comment</i>	<i>You can input any text here as the comment of this MAC address, like 'ROOM 2A Computer' or anything. You can input up to 16 alphanumerical characters here. This is optional and you can leave it blank, however, it's recommended to use this field to write a comment for every MAC addresses as a memory aid. This is optional.</i>
<i>Add</i>	<i>When you finish inputting MAC address and (optional) Comment, click this button to add the MAC address to the list.</i>
<i>Clear</i>	<i>Remove all characters in 'MAC address' and 'Comments' field.</i>

After you finish with setting, please click 'Apply', and the following message will be displayed:

Save setting successfully!

You may press CONTINUE button to continue configuring other settings or press APPLY button to restart the system for changes to take effect

When you see this message, the settings you made is successfully save. You can click 'Continue' button to back to previous page and continue on other setting items, or click 'Apply' button to restart the wireless access point and the changes will take effect after about 30 seconds.

2-9 System Utilities

This access point provides some control functions include password, IP address management, and DHCP server function. Please click 'System Utility' on the left of web management interface to access these functions. Below are detailed descriptions of every control function.

2-9-1 LED On/Off

You can turn on or off the LED of this wireless access point.

Please click 'System Utility' on the left, and the following message will be displayed:

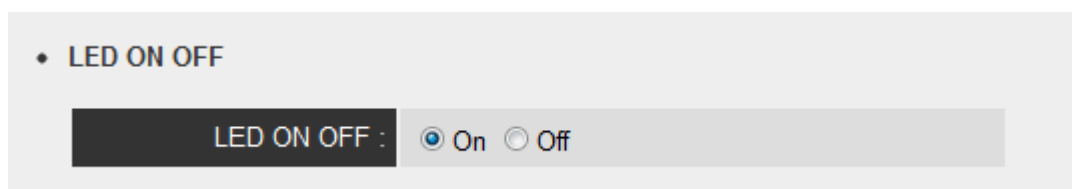

Please select the LED behavior you wish to use. After you finish, please go to the bottom of this page and click 'Apply', and the following message will be displayed:

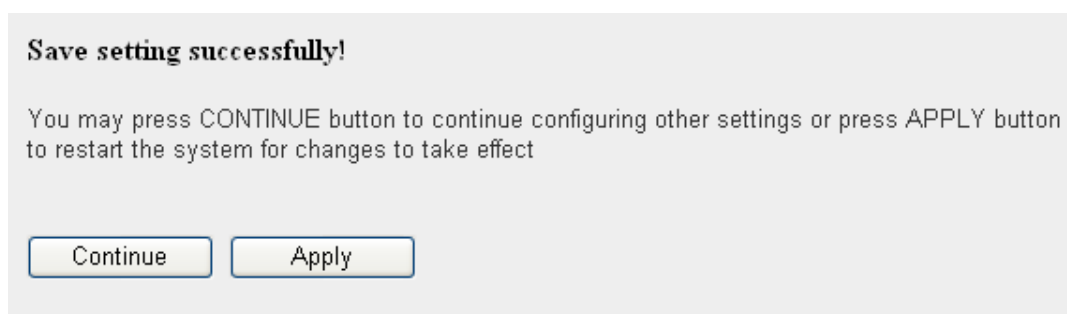

When you see this message, the settings you made is successfully save. You can click 'Continue' button to back to previous page and continue on other setting items, or click 'Apply' button to restart the wireless access point and the changes will take effect after about 30 seconds.

2-9-2 Change Password

You can change the password used to enter the web configuration menu of this wireless access point.

Please click 'System Utility' on the left, and the following message will be displayed:

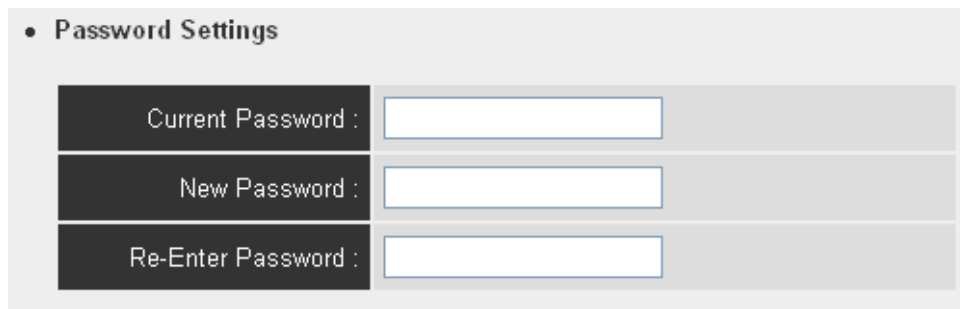

The screenshot shows a web form titled "Password Settings" with a bullet point icon. It contains three rows of input fields. Each row has a dark grey label on the left and a white text input box on the right. The labels are "Current Password :", "New Password :", and "Re-Enter Password :".

Please input current password in 'Current Password' field, then input new password in both 'New Password' and 'Re-Enter Password' field. After you finish, please go to the bottom of this page and click 'Apply', and the following message will be displayed:

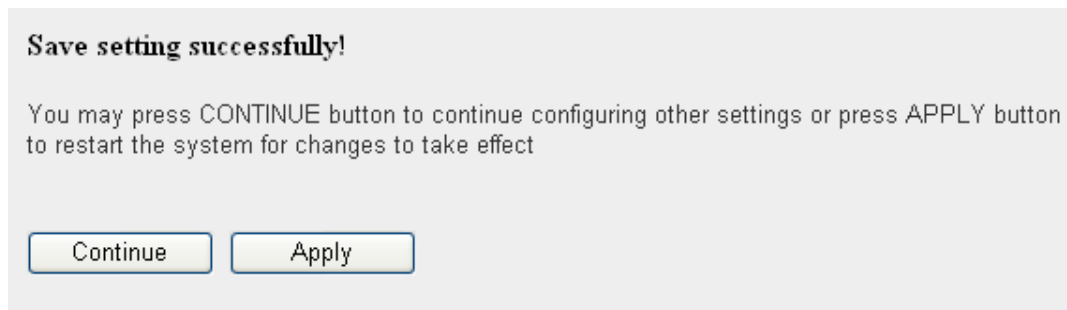

The screenshot shows a message box with a light grey background. At the top, it says "Save setting successfully!". Below that, it says "You may press CONTINUE button to continue configuring other settings or press APPLY button to restart the system for changes to take effect". At the bottom, there are two buttons: "Continue" and "Apply".

When you see this message, the settings you made is successfully save. You can click 'Continue' button to back to previous page and continue on other setting items, or click 'Apply' button to restart the wireless access point and the changes will take effect after about 30 seconds.

2-9-3 IP Address of the Wireless Access Point

You can change the IP address of this wireless access point, so it can become a part of your local network. Please remember this address or you will not be able to connect the configuration menu of this wireless access point.

Default IP address is: 192.168.2.1 / Subnet Mask 255.255.255.0, you can press and hold 'Reset/WPS' button over 10 seconds to change the IP address back to default value if you forget the IP address you set.

To change IP address, please click 'System Utility' on the left, and the following message will be displayed:

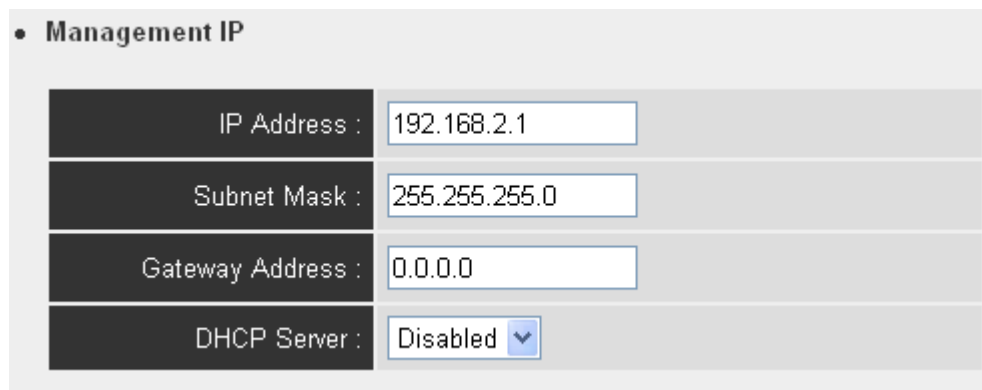

The screenshot shows a configuration window titled "Management IP". It contains four rows of input fields:

IP Address :	<input type="text" value="192.168.2.1"/>
Subnet Mask :	<input type="text" value="255.255.255.0"/>
Gateway Address :	<input type="text" value="0.0.0.0"/>
DHCP Server :	<input type="button" value="Disabled"/> ▾

Please input IP address and Subnet Mask in corresponding field, and you can input the IP address of gateway in 'Gateway Address' field, if you need to manage this wireless access point from other network (like Internet).

If you want to activate the DHCP server function of this wireless access point, please select 'Enabled' in 'DHCP Server' option, and see next Section for detailed instructions; if you don't want to use DHCP server function of this wireless access point, or there's another DHCP server on the network this access point connects to, please select 'Disable'.

After you finish, please go to the bottom of this page and click ‘Apply’, and the following message will be displayed:

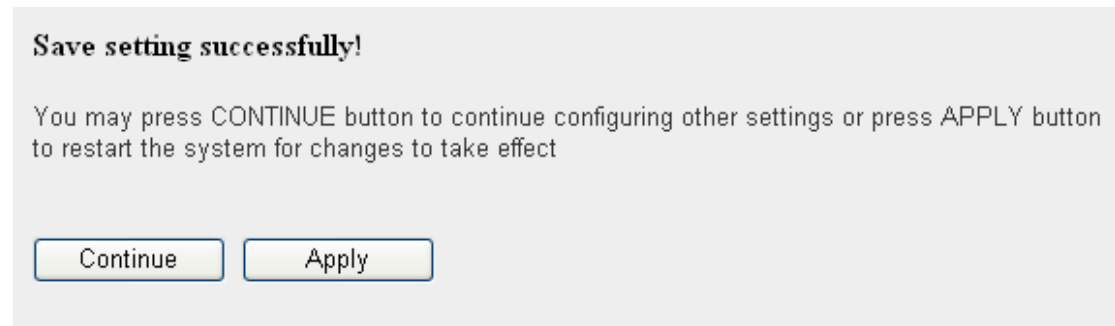

When you see this message, the settings you made is successfully save. You can click ‘Continue’ button to back to previous page and continue on other setting items, or click ‘Apply’ button to restart the wireless access point and the changes will take effect after about 30 seconds.

2-9-4 DHCP Server

This wireless access point is capable to act as a DHCP server for your network, and it's disabled by default. If you want to activate this function, please click 'System Utility' on the left, and the following message will be displayed:

• DHCP Server

Default Gateway IP :	<input type="text" value="0.0.0.0"/>
Domain Name Server IP :	<input type="text" value="0.0.0.0"/>
Start IP :	<input type="text" value="192.168.2.100"/>
End IP :	<input type="text" value="192.168.2.200"/>
Domain Name :	<input type="text"/>
Lease Time :	<input type="text" value="Forever"/>

NOTE: Please remember to select 'Enable' in 'DHCP Server' option as described in last Section or all DHCP-related fields will be grayed out, and you will not be able to input any DHCP parameter.

Here are descriptions of every setup item:

<i>Default Gateway IP</i>	<i>Please input the IP address of default gateway of your network here.</i>
<i>Domain Name Server IP</i>	<i>Please input the IP address of domain name server (DNS) here.</i>
<i>Start IP</i>	<i>Please input the start IP address of the IP range.</i>
<i>End IP</i>	<i>Please input the end IP address of the IP range.</i>
<i>Domain Name</i>	<i>If you wish, you can also optionally input the domain name for your network. This is optional.</i>
<i>Lease Time</i>	<i>Please choose a lease time (the duration that every computer can keep a specific IP address) of every IP address assigned by this access point from dropdown menu.</i>

After you finish, please click 'Apply', and the following message will be displayed:

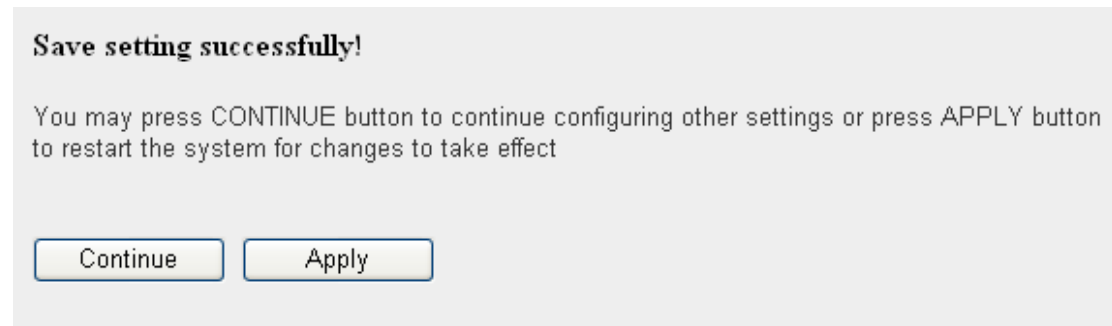

When you see this message, the settings you made is successfully save. You can click 'Continue' button to back to previous page and continue on other setting items, or click 'Apply' button to restart the wireless access point and the changes will take effect after about 30 seconds.

Chapter III: Advanced Configuration

3-1 Configuration Backup and Restore

You can backup all configurations of this access point to a file, so you can make several copied of access point configuration for security reason.

To backup or restore access point configuration, please follow the following instructions:

Please click ‘Configuration Tool’ on the left of web management interface, and the following message will be displayed on your web browser:

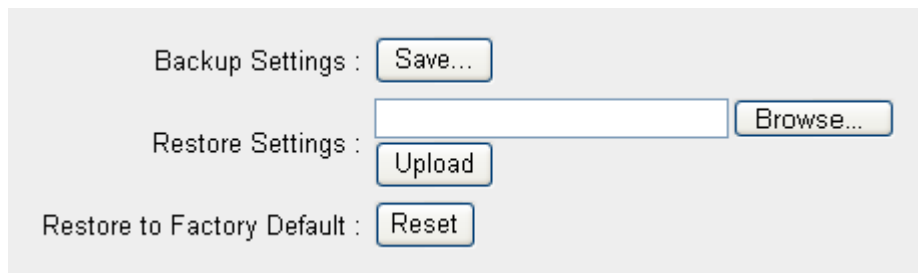

The screenshot shows a web interface with three sections:

- Backup Settings :** A button labeled "Save...".
- Restore Settings :** A text input field followed by a "Browse..." button, and an "Upload" button below it.
- Restore to Factory Default :** A "Reset" button.

Here are descriptions of every buttons:

<i>Backup Settings</i>	<i>Press ‘Save...’ button, and you’ll be prompted to download the configuration as a file, default filename is ‘config.bin’, you can save it as another filename for different versions, and keep it in a safe place.</i>
<i>Restore Settings</i>	<i>Press ‘Browse...’ to pick a previously-saved configuration file from your computer, and then click ‘Upload’ to transfer the configuration file to access point. After the configuration is uploaded, the access point’s configuration will be replaced by the file you just uploaded.</i>
<i>Restore to Factory Default</i>	<i>Click this button to remove all settings you made, and restore the configuration of this access point back to factory default settings.</i>

3-2 Firmware Upgrade

If there are new firmware of this wireless access point available, you can upload the firmware to the access point to change the firmware with new one, to get extra functions or problem fix.

To perform firmware upgrade, please click 'Upgrade' on the left of web management interface, and the following message will be displayed:

WEB Upgrade

This tool allows you to upgrade the Access Point's system firmware. It is recommended that upgrading the firmware from wired stations.
Enter the path and name of the upgrade file and then click the APPLY button below. You will be prompted to confirm the upgrade.

Click 'Browse' button first, you'll be prompted to provide the filename of firmware upgrade file. Please download the latest firmware file from our website, and use it to upgrade your access point.

After a firmware upgrade file is selected, click 'Apply' button, and the access point will start firmware upgrade procedure automatically. The procedure may take several minutes, please be patient.

NOTE: Never interrupt the upgrade procedure by closing the web browser or physically disconnect your computer from access point. If the firmware you uploaded is corrupt, the firmware upgrade will fail, and you may have to return this access point to the dealer of purchase to ask for help. (Warranty voids if you interrupted the upgrade procedure).

3-3 System Reset

When you think the access point is not working properly, you can use this function to restart the access point; this may help and solve the problem.

This function is useful when the access point is far from you or unreachable. However, if the access point is not responding, you may have to switch it off by unplugging the power plug and plugging it back again after 10 seconds.

To reset your access point, please click 'Reset' on the left, and the following message will be displayed:

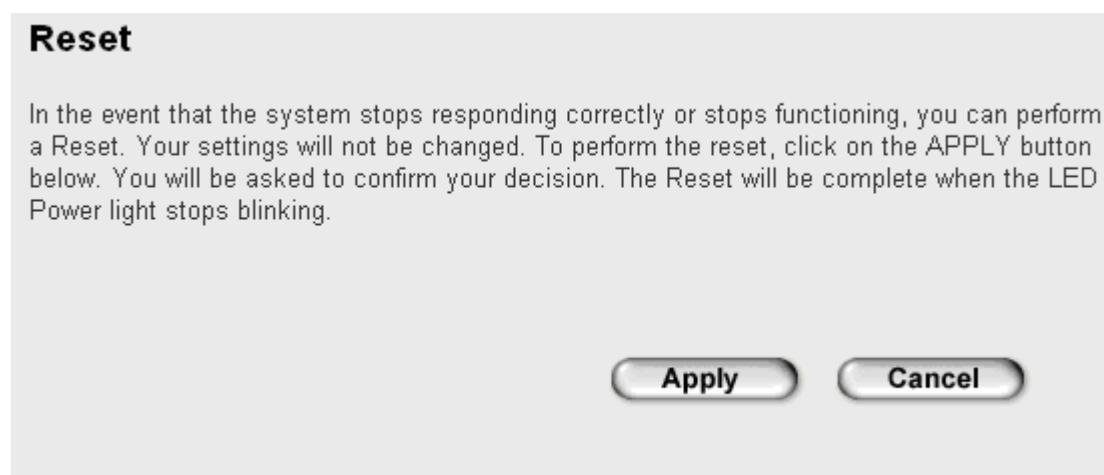

Please click 'Apply', and a popup message will ask you again, to make sure you really want to reset the access point:

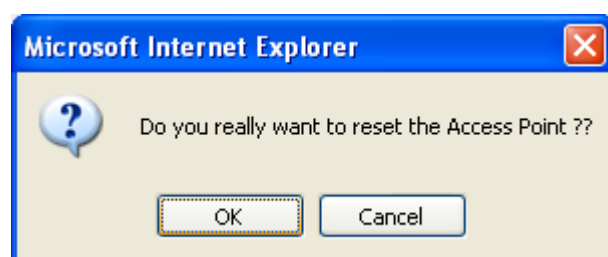

Click 'OK' to reset the access point, or click 'Cancel' to abort. Please remember all connections between wireless client and this access point will be disconnected.

Chapter IV: Appendix

4-1 Hardware Specification

SoC: Realtek RTL8196C + RTL8192CE

Flash: 2MB

SDRAM: 16MB

LAN Port: 10/100M UTP Port x 1

Antenna: Built in Antenna x 2

Power: 5VDC, 2A Switching Power Adapter

Dimension: 46(H) x 105(W) x 105(D) mm

Transmit Power: 11n:23dBm \pm 1.5dBm, 11g:23dBm \pm 1.5dBm, 11b:25 \pm 1.5dBm

Temperature: 32~104°F (0 ~ 40°C)

Humidity: 10-90% (NonCondensing)

4-2 Troubleshooting

If you found the access point is working improperly or stop responding to you, don't panic! Before you contact your dealer of purchase for help, please read this troubleshooting first. Some problems can be solved by yourself within very short time!

Scenario	Solution
Access point is not responding to me when I want to access it by web browser	<ol style="list-style-type: none">a. Please check the connection of power cord and network cable of this access point. All cords and cables should be correctly and firmly inserted to the access point.b. If all LEDs on this access point are out, please check the status of A/C power adapter, and make sure it's correctly powered.c. You must use the same IP address section which access point uses.d. Are you using MAC or IP address filter? Try to connect the access point by another computer and see if it works; if not, please perform a hard reset (pressing 'reset' button).e. Set your computer to obtain an IP address automatically (DHCP), and see if your computer can get an IP address.f. If you did a firmware upgrade and this happens, contact your dealer of purchase for help.g. If all above solutions don't work, contact the dealer of purchase for help.
Can't get connected to wireless access point	<ol style="list-style-type: none">a. If encryption is enabled, please re-check WEP or WPA passphrase settings on your wireless client.b. Try to move closer to wireless access point.c. Unplug the power plug of access point, and plug it back again after 10 seconds.d. If all LEDs on this access point are out,

	<p>please check the status of A/C power adapter, and make sure it's correctly powered.</p>
<p>I can't locate my access point by my wireless client</p>	<p>a. 'Broadcast ESSID' set to off? b. Is Antenna properly installed and secured? c. Are you too far from your access point? Try to get closer. d. Please remember that you have to input ESSID on your wireless client manually, if ESSID broadcast is disabled.</p>
<p>File download is very slow or breaks frequently</p>	<p>a. Try to reset the access point and see if it's better after that. b. Try to know what computers do on your local network. If someone's transferring big files, other people will think Internet is really slow. c. Change channel number and see if this works.</p>
<p>I can't log onto web management interface: password is wrong</p>	<p>a. Make sure you're connecting to the correct IP address of the access point! b. Password is case-sensitive. Make sure the 'Caps Lock' light is not illuminated. c. If you really forget the password, do a hard reset.</p>
<p>Access point become hot</p>	<p>a. This is not a malfunction, if you can keep your hand on the access point's case. b. If you smell something wrong or see the smoke coming out from access point or A/C power adapter, please disconnect the access point and A/C power adapter from utility power (make sure it's safe before you're doing this!), and call your dealer of purchase for help.</p>

4-3 Glossary

Default Gateway (Access point): Every non-access point IP device needs to configure a default gateway's IP address. When the device sends out an IP packet, if the destination is not on the same network, the device has to send the packet to its default gateway, which will then send it out towards the destination.

DHCP: Dynamic Host Configuration Protocol. This protocol automatically gives every computer on your home network an IP address.

DNS Server IP Address: DNS stands for Domain Name System, which allows Internet servers to have a domain name (such as `www.Broadbandaccess point.com`) and one or more IP addresses (such as `192.34.45.8`). A DNS server keeps a database of Internet servers and their respective domain names and IP addresses, so that when a domain name is requested (as in typing "`Broadbandaccess point.com`" into your Internet browser), the user is sent to the proper IP address. The DNS server IP address used by the computers on your home network is the location of the DNS server your ISP has assigned to you.

DSL Modem: DSL stands for Digital Subscriber Line. A DSL modem uses your existing phone lines to transmit data at high speeds.

Ethernet: A standard for computer networks. Ethernet networks are connected by special cables and hubs, and move data around at up to 10/100 million bits per second (Mbps).

Idle Timeout: Idle Timeout is designed so that after there is no traffic to the Internet for a pre-configured amount of time, the connection will automatically be disconnected.

IP Address and Network (Subnet) Mask: IP stands for Internet Protocol. An IP address consists of a series of four numbers separated by periods, that identifies a single, unique Internet computer host in an IP network. Example: `192.168.2.1`. It consists of 2 portions: the IP network address, and the host identifier.

The IP address is a 32-bit binary pattern, which can be represented as four cascaded decimal numbers separated by ".": `aaa.aaa.aaa.aaa`, where each "aaa" can be anything from 000 to 255, or as four cascaded binary numbers separated by ".":

`bbbbbbbbb.bbbbbbbb.bbbbbbbb.bbbbbbbb`, where each "b" can either be 0 or 1.

A network mask is also a 32-bit binary pattern, and consists of consecutive leading

1's followed by consecutive trailing 0's, such as

11111111.11111111.11111111.00000000. Therefore sometimes a network mask can also be described simply as "x" number of leading 1's.

When both are represented side by side in their binary forms, all bits in the IP address that correspond to 1's in the network mask become part of the IP network address, and the remaining bits correspond to the host ID.

For example, if the IP address for a device is, in its binary form,

11011001.10110000.10010000.00000111, and if its network mask is,

11111111.11111111.11110000.00000000

It means the device's network address is

11011001.10110000.10010000.00000000, and its host ID is,

00000000.00000000.00000000.00000111. This is a convenient and efficient method for access points to route IP packets to their destination.

ISP Gateway Address: (see ISP for definition). The ISP Gateway Address is an IP address for the Internet access point located at the ISP's office.

ISP: Internet Service Provider. An ISP is a business that provides connectivity to the Internet for individuals and other businesses or organizations.

LAN: Local Area Network. A LAN is a group of computers and devices connected together in a relatively small area (such as a house or an office). Your home network is considered a LAN.

MAC Address: MAC stands for Media Access Control. A MAC address is the hardware address of a device connected to a network. The MAC address is a unique identifier for a device with an Ethernet interface. It is comprised of two parts: 3 bytes of data that corresponds to the Manufacturer ID (unique for each manufacturer), plus 3 bytes that are often used as the product's serial number.

NAT: Network Address Translation. This process allows all of the computers on your home network to use one IP address. Using the broadband access point's NAT capability, you can access the Internet from any computer on your home network without having to purchase more IP addresses from your ISP.

Port: Network Clients (LAN PC) uses port numbers to distinguish one network application/protocol over another. Below is a list of common applications and protocol/port numbers:

Application	Protocol	Port Number
Telnet	TCP	23
FTP	TCP	21
SMTP	TCP	25
POP3	TCP	110
H.323	TCP	1720
SNMP	UCP	161
SNMP Trap	UDP	162
HTTP	TCP	80
PPTP	TCP	1723
PC Anywhere	TCP	5631
PC Anywhere	UDP	5632

PPPoE: Point-to-Point Protocol over Ethernet. Point-to-Point Protocol is a secure data transmission method originally created for dial-up connections; PPPoE is for Ethernet connections. PPPoE relies on two widely accepted standards, Ethernet and the Point-to-Point Protocol. It is a communications protocol for transmitting information over Ethernet between different manufacturers

Protocol: A protocol is a set of rules for interaction agreed upon between multiple parties so that when they interface with each other based on such a protocol, the interpretation of their behavior is well defined and can be made objectively, without confusion or misunderstanding.

Access point: A access point is an intelligent network device that forwards packets between different networks based on network layer address information such as IP addresses.

Subnet Mask: A subnet mask, which may be a part of the TCP/IP information provided by your ISP, is a set of four numbers (e.g. 255.255.255.0) configured like an IP address. It is used to create IP address numbers used only within a particular network (as opposed to valid IP address numbers recognized by the Internet, which must be assigned by InterNIC).

TCP/IP, UDP: Transmission Control Protocol/Internet Protocol (TCP/IP) and

Unreliable Datagram Protocol (UDP). TCP/IP is the standard protocol for data transmission over the Internet. Both TCP and UDP are transport layer protocol. TCP performs proper error detection and error recovery, and thus is reliable. UDP on the other hand is not reliable. They both run on top of the IP (Internet Protocol), a network layer protocol.

WAN: Wide Area Network. A network that connects computers located in geographically separate areas (e.g. different buildings, cities, countries). The Internet is a wide area network.

Web-based management Graphical User Interface (GUI): Many devices support a graphical user interface that is based on the web browser. This means the user can use the familiar Netscape or Microsoft Internet Explorer to Control/configure or monitor the device being managed.